

SHARP

MUSIC SYSTEM FOR iPod

MODEL

DK-AP2 DK-AP2(BK)

OPERATION MANUAL



iPod is a trademark of Apple Inc.,
registered in the U.S. and other countries.

**Thank you for purchasing this SHARP product.
To obtain the best performance from this product, please read this
manual carefully. It will guide you in operating your SHARP product.**

The illustrations printed in this operation manual are for the model
DK-AP2.

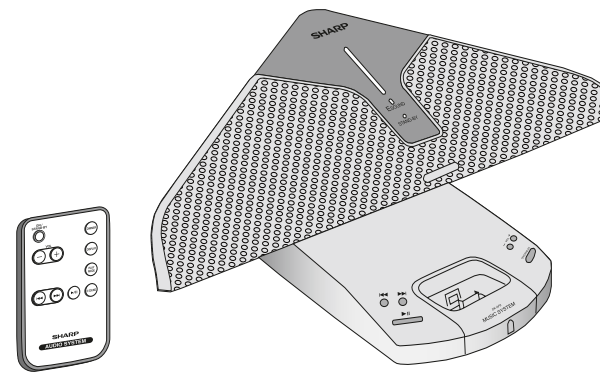

Special notes

WARNINGS

- When the ON/STAND-BY button is set at STAND-BY position, mains voltage is still present inside the unit. When the ON/STAND-BY button is set at STAND-BY position, the unit may be brought into operation by the remote control.
- This unit contains no user serviceable parts. Never remove covers unless qualified to do so. This unit contains dangerous voltages, always remove mains plug from the socket before any service operation and when not in use for a long period.
- The supplied AC/DC adaptor contains no user serviceable parts. Never remove covers unless qualified to do so. It contains dangerous voltages, always remove mains plug from the main outlet socket before any service operation or when not in use for a long period.
- The AC/DC adaptor supplied with the DK-AP2/DK-AP2(BK) must not be used with other equipment.
- Never use an AC/DC adaptor other than the one specified. Otherwise, problems or serious hazards may be created.
- To prevent fire or shock hazard, do not expose this appliance to dripping or splashing. No objects filled with liquids, such as vases, shall be placed on the apparatus.
- Do not turn the volume on to full at switch on. Listen to music at moderate levels.

Note for users in Australia:

Copyright may exist in material you wish to record. Copying or broadcasting such material without permission of the relevant licensees or owners of the copyright is prohibited by law. SHARP is not in a position to authorise the copying or broadcasting of copyright materials and nothing in this OPERATION MANUAL should be implied as giving that authority.

For other countries:

Audio-visual material may consist of copyrighted works which must not be recorded without the authority of the owner of the copyright. Please refer to the relevant laws in your country.

Accessories

Please confirm that the following accessories are included.

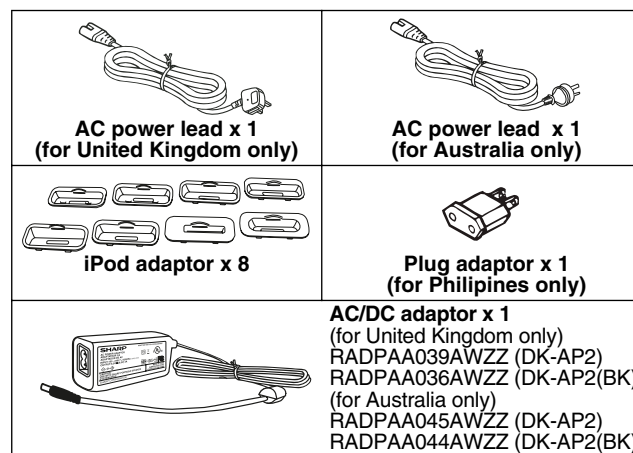
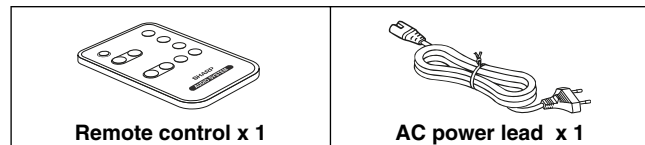

Note:

The AC/DC adaptor may be different from the one in the drawing.

Contents

■ General Information	Page
Precautions	3
Controls and indicators	4 - 5
■ Preparation for Use	
System connections	6 - 7
Remote control	7 - 8
■ Basic Operation	
General control	8
■ iPod	
Listening to the iPod	9 - 11
■ Advanced Feature	
Enhancing your system	12
■ References	
Troubleshooting chart	12 - 13
Maintenance	13
Specifications	13

Precautions

DK-AP2
DK-AP2(BK)

■ General

- Please ensure that the equipment is positioned in a well-ventilated area and ensure that there is at least 10 cm (4") of free space along the sides, top and back of the equipment.

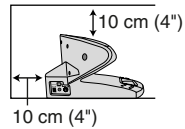

- Use the unit on a firm, level surface free from vibration.

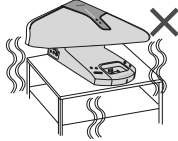

- Keep the unit away from direct sunlight, strong magnetic fields, excessive dust, humidity and electronic/electrical equipment (home computers, facsimiles, etc.) which generate electrical noise.

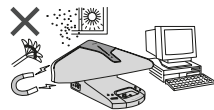

- Do not place anything on top of the unit.
- Do not expose the unit to moisture, to temperatures higher than 60°C (140°F) or to extremely low temperatures.
- If your system does not work properly, disconnect the AC power lead from the wall socket. Plug the AC power lead back in, and then turn on your system.
- In case of an electrical storm, unplug the unit for safety.
- Do not use an external power supply other than the 6V DC supplied with this unit as it may be damaged.
- SHARP is not responsible for damage due to improper use. Refer all servicing to a SHARP authorised service centre.

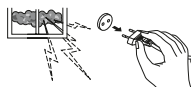

- Hold the AC power plug by the head when removing it from the wall socket, as pulling the lead can damage internal wires.
- The AC power plug is used as disconnect device and shall always remain readily operable.
- **Do not remove the outer cover, as this may result in electric shock. Refer internal service to your local SHARP service facility.**

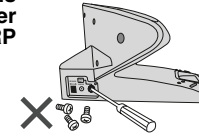

- The ventilation should not be impeded by covering the ventilation openings with items, such as newspapers, tablecloths, curtains, etc.

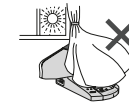

- No naked flame sources, such as lighted candles, should be placed on the apparatus.
- Attention should be drawn to the environmental aspects of battery disposal.
- This unit should only be used within the range of 5°C - 35°C (41°F - 95°F).
- The apparatus is designed for use in moderate climate.

Warning:

The voltage used must be the same as that specified on this unit. Using this product with a higher voltage other than that which is specified is dangerous and may result in a fire or other type of accident causing damage. SHARP will not be held responsible for any damage resulting from use of this unit with a voltage other than that which is specified.

■ Volume control

The sound level at a given volume setting depends on speaker efficiency, location, and various other factors. It is advisable to avoid exposure to high volume levels. Do not turn the volume on to full at switch on. Listen to music at moderate levels.

Controls and indicators

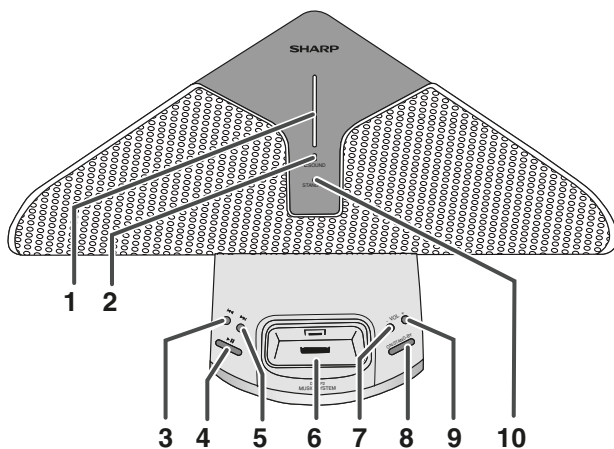

■ Top view

	Reference page
1. Power Indicator	6, 8
2. E SOUND Indicator	8
3. Skip Down Button	11
4. Play/Pause Button	10, 11
5. Skip Up Button	11
6. iPod Dock	10
7. Volume Down Button	8
8. ON/STAND-BY Button	8
9. Volume Up Button	8
10. Stand-by Indicator	8

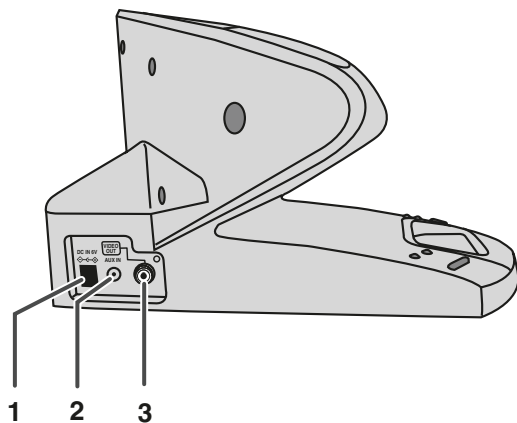

■ Side view

	Reference page
1. DC Input Socket	6
2. Auxiliary Input Socket	12
3. Video Out Socket	6

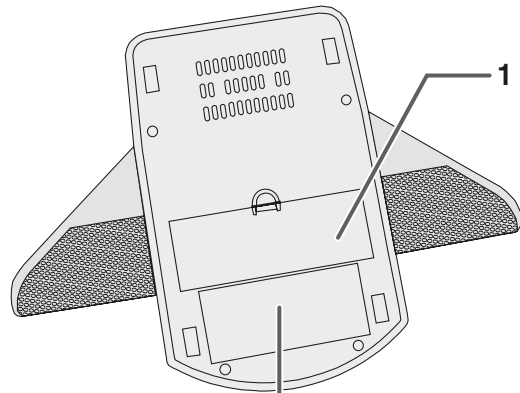

The spec label (*)

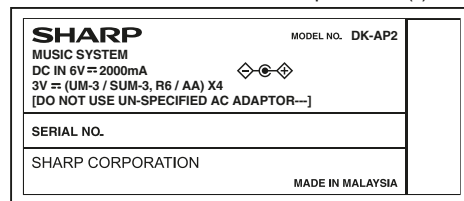

The spec label illustration may be different from the actual label used.

(*) Label is located at the bottom of the unit.

■ **Bottom view**

	Reference page
1. Battery Compartment	7

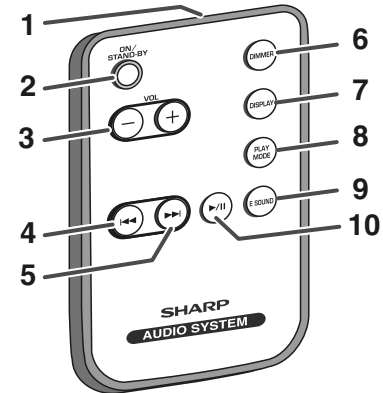

■ **Remote control**

	Reference page
1. Remote Control Transmitter	8
2. On/Stand-by Button	8
3. Volume Up and Down Buttons	8
4. Skip Down Button	11
5. Skip Up Button	11
6. Dimmer Button	17
7. Display Button	11
8. Play Mode Button	11
9. E SOUND	8
10. Play/Pause Button	10, 11

Note:

Before using remote control, please remove plastic shield at battery holder.

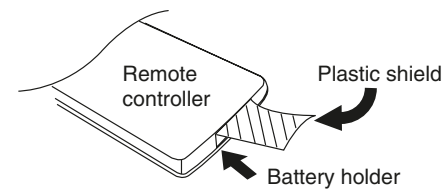

System connections

Make sure to unplug the AC power lead before any connections.

■ Connecting iPod to TV

iPod photo and 5th Generation iPod with photo and video can be viewed by connecting to TV/monitor. If the TV/monitor has a video input, connect it to the VIDEO OUT socket at the side of the unit.

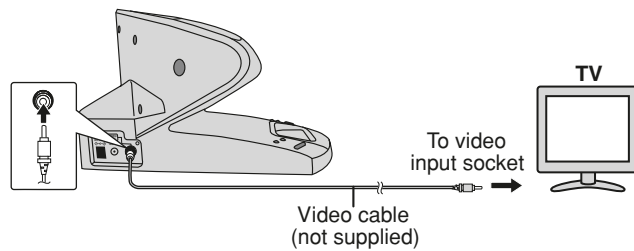

■ Using with the AC/DC adaptor

- 1 Plug the AC power lead into the AC/DC adaptor.**
- 2 Plug the AC/DC adaptor cable into the DC INPUT socket on the unit.**
- 3 Plug the AC power lead into a wall socket and switch on the power supply. The STAND-BY indicator turns red and when the power is on, the POWER indicator turns blue.**

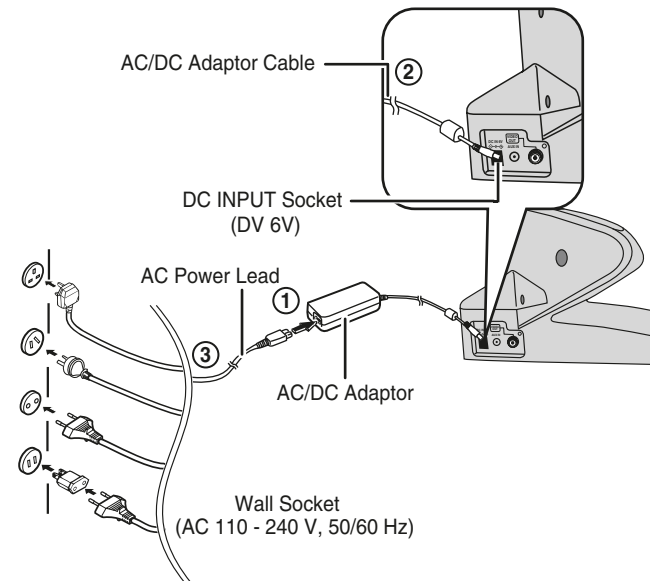

Notes:

- Unplug the AC/DC adaptor from the wall socket if the unit will not be used for a prolonged period of time.
- Connecting the AC/DC adaptor to the unit disconnects the batteries.
- Use only the supplied AC/DC adaptor. Using other AC/DC adaptor may cause an electric shock or fire.

■ Using with the batteries

1 Disconnect the AC/DC adaptor, and open the battery compartment.

2 Insert 4 “AA” size batteries (UM-3, R6 or similar) into the battery compartment.

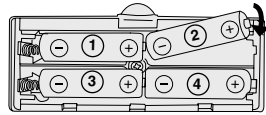

“AA” size batteries (UM-3, R6 or similar) are not included.

Battery insertion:

Slide in batteries ① and ③. Then push batteries ② and ④ towards ⊖.

Battery removal:

Push batteries ② and ④ towards ⊖ and remove the batteries before sliding out batteries ① and ③.

3 Close the battery compartment.

4 The STAND-BY indicator will turn red.

Remove the batteries if the unit is not to be used for long period of time to prevent battery leakage which may cause potential damage.

Battery replacement:

When batteries are low, sound becomes distorted and indicators will be blinking. Reduce the volume level or replace the batteries with new ones.

Battery life

Battery type	ALKALINE (AA) (1.5V)
Usage time	Approx. 8 hrs.
Output	74mW + 74mW

Note:

Battery life may vary depending on the temperature, battery types and usage conditions.

Precautions for battery use:

- Installing the batteries incorrectly may cause the unit to malfunction.
- Insert the batteries according to the direction indicated in the battery compartment.
- Remove the batteries if the unit is not to be used for long periods of time. This will prevent potential damage due to battery leakage.

- Replace all old batteries with new ones at the same time.
- Do not mix old and new batteries.
- Batteries (battery pack or batteries installed) shall not be exposed to excessive heat such as sunshine, fire or the like.

Caution:

Do not use rechargeable batteries (nickel-cadmium battery, etc.).

Changing power source:

Turn off the unit before changing the power source. If the 6V DC power supply is directly plugged in during power on, the unit will automatically enter the stand-by mode. Press the ON/STAND-BY button again to turn on the unit.

Remote control

■ Battery installation

This product contains a CR Coin Lithium Battery which contains Perchlorate Material – special handling may apply. California residents, see www.dtsc.ca.gov/hazardouswaste/perchlorate/

1 Whilst pushing the locking tab towards the centre of the remote control, slide out the battery holder.

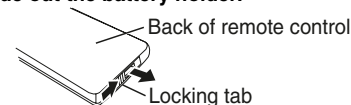

2 Remove the old battery from the battery holder, insert the new battery and then slide the battery holder back into the remote control.

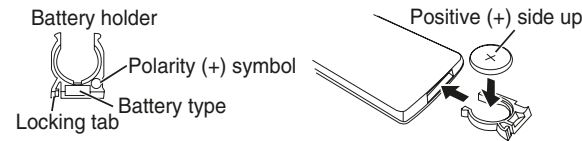

Precautions for battery use:

- Remove the battery if the unit will not be used for long periods of time. This will prevent potential damage due to battery leakage.

Caution:

- Do not use rechargeable battery (nickel-cadmium battery, etc.).
- Replace only with the same or equivalent type.
- Installing the battery incorrectly may cause the unit to malfunction.
- Danger of explosion if battery is incorrectly replaced.
- Batteries (battery pack or batteries installed) shall not be exposed to excessive heat such as sunshine, fire or the like.

Remote control (continued)

Notes concerning use:

- Replace the battery if the operating distance is reduced or if the operation becomes erratic. Purchase "CR 2025", coin lithium battery.
- Periodically clean the transmitter on the remote control and the sensor on the unit with a soft cloth.
- Exposing the sensor on the unit to strong light may interfere with operation. Change the lighting or the direction of the unit if this occurs.
- Keep the remote control away from moisture, heat, shock, and vibrations.

■ Test of the remote control

Check the remote control after checking all the connections (see pages 6 - 7).
Point the remote control directly at the remote sensor on the unit.

The remote control can be used within the range shown below:
Press the ON/STAND-BY button. Does the power turn on? Now, you can enjoy the music.

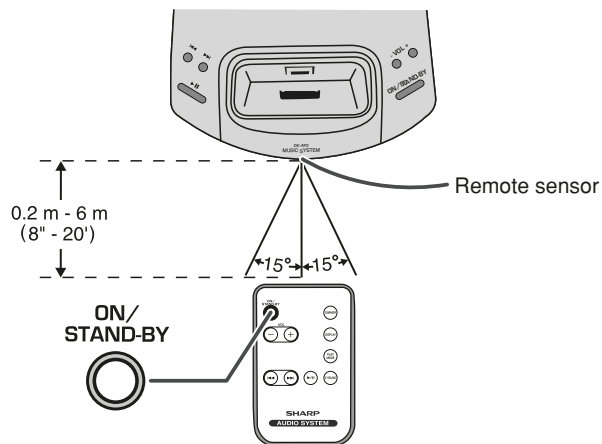

General control

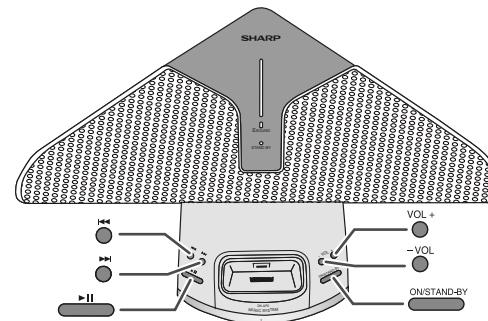

■ To turn the power on

Press the ON/STAND-BY button to turn the power on. The POWER indicator turns blue to indicate power on.

After use:

Press the ON/STAND-BY button to enter the power stand-by mode. STAND-BY indicator turns red, and the POWER indicator goes off.

■ Volume control

Main unit and remote control operation:

Press the VOL (+ or -) button to increase or decrease the volume. POWER indicator will be blinking when the volume reaches maximum or minimum level.

■ E SOUND control

Press the E SOUND button on the remote control. The E SOUND indicator turns yellowish orange. You are now in the E SOUND mode, where low bass and high frequency are automatically adjusted according to the volume input.

To turn off E SOUND, press the E SOUND button again. The E SOUND indicator will go off.

Listening to the iPod

DK-AP2
DK-AP2(BK)

Supported iPod models:

- iPod nano (software 1.0 above)
- iPod photo (software 1.0 above)
- iPod mini (software 1.2 above)
- 5th Generation iPod (software 1.0 above) (Dock connector equipped Click Wheel model)
- 4th Generation iPod (software 3.0.2 above) (Dock connector equipped Click Wheel model)

Caution:

- Please update your iPod unit to the latest software version before using it. Please visit Apple's homepage to download the latest version for your iPod.

Notes:

- Once the iPod is connected to the unit it will begin charging when AC/DC adaptor is used.
- The iPod unit cannot be charged whilst the main unit is in the stand-by mode or when batteries are used as power supply.

■ iPod adaptor connection

Choose the iPod adaptor that fits your iPod. Your iPod will fit snugly into the correct adaptor. If your iPod is not mentioned below, an iPod adaptor may have been included with your iPod unit.

The number (3 - 10) shows which iPod fits



iPod Adaptor No.	iPod Description	Capacity
3	iPod mini	4GB & 6GB
4	4G iPod & U2 iPod	20GB
5	4G iPod	40GB
6	iPod photo & colour U2 iPod	20GB & 30GB
7	iPod photo	40GB & 60GB
6	iPod with colour display	20GB
7	iPod with colour display	60GB
8	iPod nano	2GB & 4GB
9	5G iPod & U2 iPod with video	30GB
10	5G iPod with video	60GB & 80GB

Notes:

- iPod nano (Second Generation) is not compatible with the original iPod nano dock adaptor.
- If you have an iPod that does not have an iPod connector, you can use an audio cable to connect it to the AUX IN socket.

Listening to the iPod (continued)

■ To insert iPod adaptor

1. Insert the iPod adaptor into unit and connect your iPod.

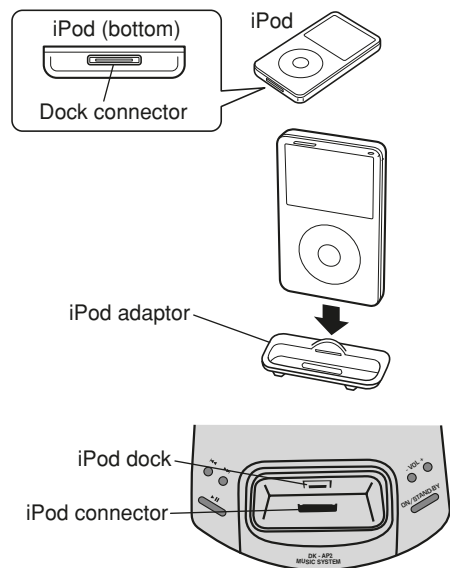

■ To remove iPod adaptor

Insert the tip of a screwdriver ("-" type, small) into the iPod adaptor hole as shown and lift upward to remove.

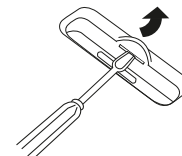

■ iPod playback

Note:

Do not connect the Audio cable to AUX IN socket during iPod playback. Otherwise, sound from the iPod will not be heard.

1 Press the ON/STAND-BY button to turn the power on.

2 Insert iPod unit in the iPod dock of main unit.

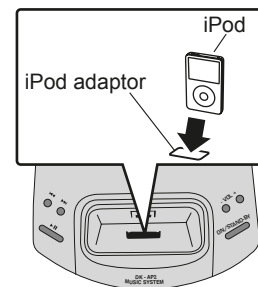

3 Press the ► / II button to start playback.













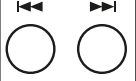

■ To disconnect iPod

Simply remove the iPod from the iPod dock. It is safe to do so even during playback.

■ Various iPod functions

iPod operation

The operations described below depend on the generation iPod you are using.

Function	Main unit	Remote control	Operation
Play			Press in the pause mode.
Pause			Press in the playback mode.
Skip up/down			Press in the playback or pause mode. If you press the button in the pause mode, press the ► / button to start the desired track.
Fast forward/reverse			Press and hold down in the playback mode. Release the button to resume playback.
Display			iPod back light ON.
Repeat			Press to toggle repeat mode.
Shuffle			Press and hold down to toggle shuffle mode.

Caution:

Unplug all accessories for the iPod before inserting it into the iPod dock.

Enhancing your system

The connection lead is not included. Purchase a commercially available lead as shown below.

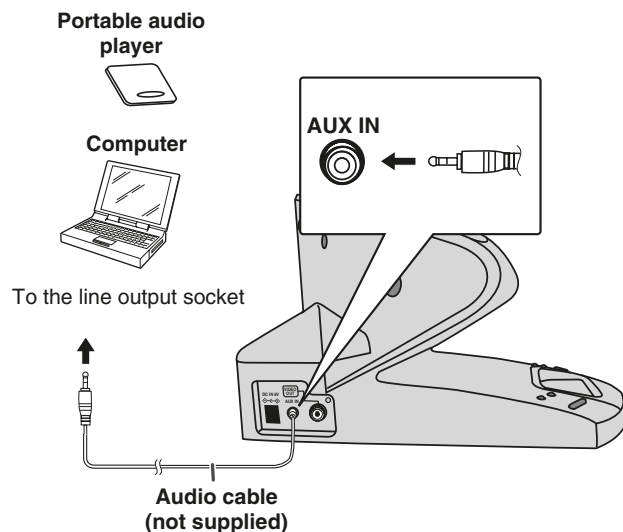

■ Listening to the playback sounds from portable audio player, computer, etc.

- 1 Use Audio cable to connect the portable audio player, computer etc. to the AUX IN socket.**
When using video equipment, connect the audio output to this unit and the video output to a television.
- 2 Press the ON/STAND-BY button to turn the power on.**
- 3 Play the connected equipment.**

Note:

To prevent noise interference, place the unit away from the television.

Troubleshooting chart

Many potential problems can be resolved by the owner without calling a service technician. If something is wrong with this product, check the following before calling your authorised SHARP dealer or service centre.

■ General

Symptom	Possible cause
<ul style="list-style-type: none"> ● When a button is pressed, the unit does not respond. 	<ul style="list-style-type: none"> ● Set the unit to the power stand-by mode and then turn it back on.
<ul style="list-style-type: none"> ● No sound is heard. 	<ul style="list-style-type: none"> ● Is the volume level set to "0"?

■ Remote control

Symptom	Possible cause
<ul style="list-style-type: none"> ● The remote control does not operate. 	<ul style="list-style-type: none"> ● Is the AC power lead of the unit plugged in? ● Is the battery polarity correct? ● Is the battery dead? ● Is the distance or angle incorrect? ● Does the remote control sensor receive strong light?

■ iPod

Symptom	Possible cause
<ul style="list-style-type: none"> ● No sound is produced. No image appears on the TV/monitor. 	<ul style="list-style-type: none"> ● The iPod is not playing. ● The iPod is not properly connected to the unit. ● Is the AC power lead of the unit plugged in? ● The video cable is not properly connected. ● The TV/monitor's input selection is not properly set.
<ul style="list-style-type: none"> ● iPod will not charge. 	<ul style="list-style-type: none"> ● The iPod is not making full contact with the iPod connector. ● The main unit is in stand-by mode. ● The main unit is using batteries as power supply.

Specifications

As part of our policy of continuous improvement, SHARP reserves the right to make design and specification changes for product improvement without prior notice. The performance specification figures indicated are nominal values of production units. There may be some deviations from these values in individual units.

■ General

Power source	DC 6V: AC/DC Adaptor (AC 100 - 240V, 50/60Hz) DC 3V: "AA" size (UM/SUM-3, R3 or HP-7) x 4
Power consumption	Power on : 3.8 W Power stand-by: 0.2 W*
Output power	Speakers: RMS: 3.8 W (1.9 W + 1.9 W) (10% T.H.D.)
Speaker	1-way type speaker system Speakers: 5 cm (2") - 6 ohms - Full Range
Speaker maximum input power	Speakers: 3.8 W/Channel
Speaker rated input power	Speakers: 1.9 W/Channel
Output terminals	Video output: 1Vp-p
Input terminals	Auxiliary (audio signal): 500 mV/47 k ohms
Dimensions	Width: 380 mm (15") Height: 157 mm (6-2/5") Depth: 221 mm (8-7/10")
Weight	1.2 kg (2.65 lbs)

* This power consumption value is obtained when in the power . . . stand-by mode.

■ Condensation

Sudden temperature changes, storage or operation in an extremely humid environment may cause condensation inside the cabinet or on the transmitter or the remote control.

Condensation can cause the unit to malfunction. If this happens, leave the power on until normal playback is possible (about 1 hour). Wipe off any condensation on the transmitter with a soft cloth before operating the unit.

■ If trouble occurs

When this product is subjected to strong external interference (mechanical shock, excessive static electricity, abnormal supply voltage due to lightning, etc.) or if it is operated incorrectly, it may malfunction.

If such a problem occurs, do the following:

- 1 Set the unit to the stand-by mode and turn the power on again.
- 2 If the unit is not restored in the previous operation, unplug and plug in the unit, and then turn the power on.

■ Before transporting the unit

Remove the iPod from the unit. Then, set the unit to the power stand-by mode. Carrying the unit with iPod left docked might damage both the unit and the iPod.

Maintenance

■ Cleaning the cabinet

Periodically wipe the cabinet with a soft cloth and a diluted soap solution, then with a dry cloth.

Caution:

- Do not use chemicals for cleaning (petrol, paint thinner, etc.). It may damage the cabinet finish.
- Do not apply oil to the inside of the unit. It may cause malfunctions.

MEMO

MEMO

SHARP
SHARP CORPORATION

TINSEA187AWZZ
07G RMW ①

03/11/4 DK-AP2_BACK.fm