

SHARP

**OPERATION MANUAL
AND
COOKBOOK**



Carousel™
MICROWAVE OVEN

MODEL R-490N(S) (J)

SHARP

WARRANTY

Consumer Electronic Products

Congratulations on Your Purchase!

This Sharp product is warranted against faults in materials and manufacture for a period of twelve(12) months from the date of original purchase.

If service is required during the warranty period, please contact your nearest Sharp Approved Service Centre. These repairs would be carried out at no charge to the owner, subject to the conditions specified herein.

The owner is responsible for any transportation and insurance costs if the product has to be returned for repair.

This warranty does not extend to accessories or defects or injuries caused by or resulting from causes not attributable to faulty parts or the manufacture of the product, including but not limited to, defect or injury caused by or resulting from misuse, abuse, neglect, accidental damage, improper voltage, liquid spillage, vermin infestation, software, or any alterations made to the product which are not authorised by Sharp.

Please retain your sales documentation, as this should be produced to validate a warranty claim.

This warranty is in addition to and in no way limits, varies or excludes any express and implied rights and remedies under any relevant legislation in the country of sale.

IMPORTANT

DO NOT RETURN THIS DOCUMENT TO SHARP

For your reference, please enter the particulars of your purchase below and retain, with your purchase documentation.

Model No. _____

Serial No. _____

Date of Purchase _____

Retailer _____

SHARP
SHARP CORPORATION OF AUSTRALIA PTY. LIMITED
ABN 40 005 039 405
1 Huntingwood Drive
Huntingwood NSW 2148
SHARP CORPORATION OF NEW ZEALAND LIMITED
59 Hugo Johnston Drive
Penrose, Auckland

IMPORTANT NOTICE: This warranty applies only to products sold in Australia & New Zealand

SHARP

FOR LOCATION ENQUIRIES WITHIN

AUSTRALIA

REGARDING YOUR LOCAL

SHARP APPROVED SERVICE CENTRE

VISIT OUR WEBSITE AT

www.sharp.net.au

OR CALL SHARP CUSTOMER CARE

1300 135 022

(LOCAL CALL COST APPLY WITHIN AUSTRALIA)

SHARP CORPORATION OF AUSTRALIA PTY LTD

SHARP

FOR LOCATION ENQUIRIES WITHIN

NEW ZEALAND

REGARDING YOUR LOCAL

SHARP APPROVED SERVICE CENTRE

VISIT OUR WEBSITE AT

www.sharp.net.nz

CONTACT YOUR SELLING DEALER/RETAILER
OR CALL

SHARP CUSTOMER SERVICES

TELEPHONE: 09 573 0111

FACSIMILE: 09 573 0113

SHARP CORPORATION OF NEW ZEALAND LIMITED

INTRODUCTION

SHARP®

INFO DISPLAY COOKING SYSTEM

Thank you for buying a Sharp Microwave Oven. Your new oven has an "Information Display System" which offers you step-by-step instructions to easily guide you through each feature.

We strongly recommend however that you read this operation manual thoroughly before operating your oven, paying particular attention to the safety warnings and special notes.

The manual is divided into two sections:

1. OPERATION (P2~P20)

This section describes your oven and teaches you how to use all the features.

2. COOKING GUIDE

This section is at the back of the manual, it contains the more commonly used information such as how to prepare food, which cooking utensil to use, standing time.

It also contains recipes for automatic cooking and manual cooking.

Please take some time to read your operation manual carefully, the automatic cooking menus programmed into your new oven have been carefully developed to give optimum results when the step-by-step instructions are followed.

When selecting another home appliance, please again consider our full range of Sharp products.

Warranty	Inside of front cover
Introduction	1
Warning	2
Special Notes and Warning	3
Installation Instructions	4
Oven Diagram	5
Operation of Touch Control Panel	6
Control Panel Display	6
Touch Control Panel Layout	6
Before Operating	7
Getting Started	7
Clock Setting	7
Stop/Clear	7
To Cancel a Programme During Cooking	7
Manual Operations	8
Microwave Time Cooking	8
Sequence Cooking	9
Instant Cook	9-10
Automatic Operations	10
Notes for Automatic Operations	10
Express Menus	11
Sensor Menus	14
Healthy Menus	15
Easy Defrost	16
Quick and Easy	17
Other Convenient Features	18
Less/More Setting	18
Increasing or Decreasing Time During a Cooking Programme	18
Timer	19
Child Lock	19
Demonstration Mode	19
Alarm	19
Care and Cleaning	20
Service Call Check	20
Specifications	20
Cooking Guides	① - ⑳
Quick Reference Guide	①

WARNING

IMPORTANT SAFETY INSTRUCTIONS : READ CAREFULLY AND KEEP FOR FUTURE REFERENCE.

To reduce the risk of fire in the oven cavity:

- a. Do not overcook food.
- b. Remove wire twist-ties from paper or plastic bags before placing bag in the oven.
- c. Do not heat oil or fat for deep frying. The temperature of the oil cannot be controlled.
- d. Look at the oven from time to time when food is heated in disposable containers made of plastic, paper or other combustible materials for signs of smoke or burning.
- e. If materials inside the oven should ignite, or smoke is observed, keep oven door closed, turn oven off, and disconnect the power plug, or shut off power at the fuse or circuit breaker panel.

To reduce the risk of an explosion or delayed eruptive boiling when handling the container.

Your microwave oven is capable of heating food and beverages very quickly therefore, it is very important that you select the appropriate cooking time and power level for the type and quantity of food to be heated. If you are unsure of the cooking time and power level required, begin with low cooking times and power levels until the food is sufficiently heated evenly throughout.

Additionally:

- a. Do not place sealed containers in the oven. Babies bottles fitted with a screw cap or teat are considered to be sealed containers.
- b. Do not use excessive amount of time.
- c. When boiling liquids in the oven, use a wide-mouthed container.
- d. Stand at least for 20 seconds at the end of cooking to avoid delayed eruptive boiling of liquids.
- e. Stir the liquid before and during cooking. Use extreme care when handling the container or inserting a spoon or other utensil into the container.

This oven is for home food preparation only and should only be used for heating, cooking and defrosting food and beverage.

It is not suitable for commercial, laboratory use, or heating therapeutic devices eg. Wheat bags.

Never operate the oven whilst any object is caught or jammed between the door and the oven.

Do not try to adjust or repair the oven yourself.

It is hazardous for anyone other than a qualified service technician trained by SHARP to carry out any service or repair operation. Especially those which involve the removal of a cover which gives protection against exposure to microwave energy are very hazardous.

Do not operate the oven if it is not working correctly or damaged until it has been repaired by a qualified service technician trained by SHARP. It is particularly important that the oven door closes properly and that there is no damage to:

(1) Door (warped), (2) Hinges and Latches (broken or loosened), (3) Door Seals, Sealing Surfaces and oven cavity (buckled or deformed), (4) Burn marks on the door seal faces.

Do not bump, or catch utensils, loose clothes and your accessories on the door safety latches when removing food from the oven.

Never poke an object, particularly a metal object, through a grille or between the door and the oven while the oven is operating.

Never tamper with or deactivate the door safety latches.

Always use oven gloves to prevent burns when handling utensils that are in contact with hot food. Enough heat from the food can transfer through utensils to cause skin burns.

Should the power supply cord become damaged, it must be replaced with a special cord supplied by a SERVICE CENTRE APPROVED BY SHARP. And it must be replaced by a qualified service technician trained by SHARP in order to avoid a hazard.

If the oven lamp fails please consult your dealer or a qualified service technician trained by SHARP.

Avoid steam burns by directing steam away from the face and hands.

Slowly lift the furthest edge of a dish's cover including microwave plastic wrap etc., and carefully open popcorn and oven cooking bags away from the face.

Make sure that the power supply cord is undamaged, and that it does not run under the oven or over any hot surfaces or sharp edges.

To prevent the turntable from breaking:

- a. Before cleaning the turntable with water, leave the turntable to cool.
- b. Do not place anything hot on a cold turntable.
- c. Do not place anything cold on a hot turntable.

Do not place anything on the outer cabinet.

Do not store food or any other items inside the oven.

Make sure the utensil does not touch the interior walls during cooking.

Only allow children to use the oven without supervision when adequate instructions have been given so that the child is able to use the oven in a safe way and understands the hazards of improper use.

This appliance is not intended for use by young children or infirm persons without supervision.

This appliance is not intended for use by persons (including children) with reduced physical, sensory or mental capabilities, or lack of experience and knowledge, unless they have been given supervision or instruction concerning use of the appliance by a person responsible for their safety.

Children should be supervised to ensure that they do not play with the appliance.

SPECIAL NOTES AND WARNING

	DO	DON'T
Eggs, fruits, nuts, seeds, vegetables, sausages and oysters	<ul style="list-style-type: none"> * Puncture egg yolks and whites and oysters before cooking to prevent "explosion". * Pierce skins of potatoes, apples, squash, hot dogs, sausages and oysters so that steam escapes. 	<ul style="list-style-type: none"> * Cook eggs in shells. This prevents "explosion", which may damage the oven or injure yourself. * Cook hard/soft boiled eggs. * Overcook oysters. * Dry nuts or seeds in shells.
Popcorn	<ul style="list-style-type: none"> * Use specially bagged popcorn for the microwave oven. * Listen while popping corn for the popping to slow to 1-2 seconds. 	<ul style="list-style-type: none"> * Pop popcorn in regular brown bags or glass bowls. * Exceed maximum time on popcorn package.
Baby food	<ul style="list-style-type: none"> * Transfer baby food to small dish and heat carefully, stirring often. Check for suitable temperature to prevent burns. * Remove the screw cap and teat before warming baby bottles. After warming shake thoroughly. Check for suitable temperature. 	<ul style="list-style-type: none"> * Heat disposable bottles. * Overheat baby bottles. Only heat until warm. * Heat bottles with nipples on. * Heat baby food in original jars.
General	<ul style="list-style-type: none"> * Food with filling should be cut after heating, to release steam and avoid burns. * Use a deep bowl when cooking liquids or cereals to prevent boiling over. 	<ul style="list-style-type: none"> * Heat or cook in closed glass jars or air tight containers. * Deep fat fry. * Heat or dry wood, herbs, wet papers, clothes or flowers. * Operate the oven without a load (i.e. an absorbing material such as food or water) in the oven cavity.
Liquids (Beverages)	<ul style="list-style-type: none"> * For boiling or cooking liquids see WARNING on page 2 to prevent explosion and delayed eruptive boiling. 	<ul style="list-style-type: none"> * Heat for longer than recommended time. See REHEATING-FOOD CHART on page 35.
Canned foods	<ul style="list-style-type: none"> * Remove food from can. 	<ul style="list-style-type: none"> * Heat or cook food while in cans.
Sausage rolls, Pies, Christmas pudding	<ul style="list-style-type: none"> * Cook for the recommended time. (These foods have high sugar and/or fat contents.) 	<ul style="list-style-type: none"> * Overcook as they may catch fire.
Meats	<ul style="list-style-type: none"> * Use a microwave proof roasting rack to collect drained juices. 	<ul style="list-style-type: none"> * Place meat directly on the turntable for cooking.
Utensils	<ul style="list-style-type: none"> * Check the utensils are suitable for MICROWAVE cooking before you use them. 	<ul style="list-style-type: none"> * Use metal utensils for MICROWAVE cooking. Metal reflects microwave energy and may cause an electrical discharge known as arcing.
Aluminium foil	<ul style="list-style-type: none"> * Use to shield food to prevent over cooking. * Watch for sparking. Reduce foil or keep clear of cavity walls. 	<ul style="list-style-type: none"> * Use too much. * Shield food close to cavity walls. Sparking can damage the cavity.
Browning dish	<ul style="list-style-type: none"> * Place a suitable insulator such as a microwave and heat proof dinner plate between the turntable and the browning dish. 	<ul style="list-style-type: none"> * Exceed the preheating time recommended by the manufacturer. Excessive preheating can cause the glass turntable to shatter and/or damage internal parts of the oven.

INSTALLATION INSTRUCTIONS

1. Remove all packing materials from the oven cavity, (**do not remove the waveguide cover**), and the feature sticker from the outside of the door, if there is one. Check the unit for any damage, such as a misaligned door, damaged door seals around the door or dents inside the oven cavity or on the door. If there is any damage, please do not operate the oven until it has been checked by a **SERVICE CENTRE APPROVED BY SHARP** and repaired, if necessary.
2. Accessories provided
 - 1) Turntable
 - 2) Roller stay
 - 3) Operation manual and Cook book
3. Place the roller stay in the coupling on the oven floor, then place the turntable on to the roller stay, ensuring it is located firmly. Refer to **OVEN DIAGRAM** below. **NEVER** operate the oven without the roller stay and turntable.
4. This oven is designed to be used on a countertop, in a cabinet or built-in. It should not be installed in any area where excessive heat and steam are generated, for example, next to a conventional oven unit. The oven should be installed so as not to block ventilation openings.

Allow a space of at least 10.5cm on the top, 10cm on both sides and 5cm at the rear of the oven for adequate air circulation. When installing in a cabinet, the minimum inside dimension of the cabinet should be 750mm(W) x 420mm(H) x 496mm(D).

When building the oven into a cabinet or wall, a Sharp built-in kit model number RK-J40S (silver) is available which enables the microwave oven to be integrated within a kitchen, the kit is available from your retailer. Read carefully the installation instructions for the built- in kit before installation. This built-in kit has been tested according to Australian Standards. Sharp does not recommend the use of any other built-in kit.

If the oven is to be positioned near a conventional oven, ensure that adequate space is allowed, and a suitable heat shield is incorporated between the two to prevent damage to the oven and the built-in kit caused by heat.

WARNING: The electrical outlet must be readily accessible so that the unit can be unplugged easily in an emergency.
5. Neither the manufacturer nor the distributors can accept any liability for damage to the machine or personal injury for failure to observe the correct electrical connecting procedure.

The A.C. voltage must be single phase 230 – 240V, 50Hz.
6. This appliance must be earthed.
7. Operate the oven from a general purpose domestic outlet.

If a generator is used, do not operate the oven with non-sinusoidal outputs.

OVEN DIAGRAM

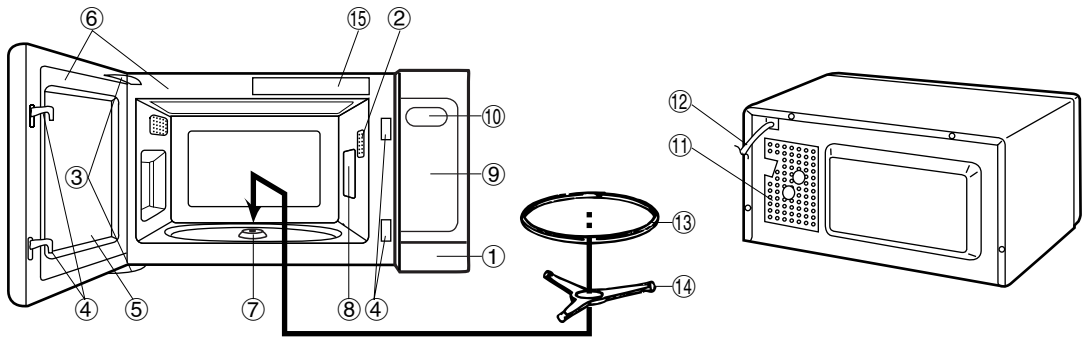

- 1. Door open button
- 2. Oven lamp
- 3. Door hinges
- 4. Door safety latches
- 5. See through door
- 6. Door seals and sealing surfaces
- 7. Coupling
- 8. Waveguide cover (Do not remove)

- 9. Touch control panel
- 10. Liquid crystal display
- 11. Ventilation openings
- 12. Power supply cord
- 13. Turntable
- 14. Roller stay
- 15. Menu label

OPERATION OF TOUCH CONTROL PANEL

The operation of the oven is controlled by pressing the appropriate pads arranged on the surface of the control panel. An entry signal tone should be heard each time you press the control panel to make a correct entry. In addition the oven will beep for approximately 2 seconds at the end of the cooking cycle, or 4 times when a cooking procedure is required.

Control Panel Display



Touch Control Panel Layout

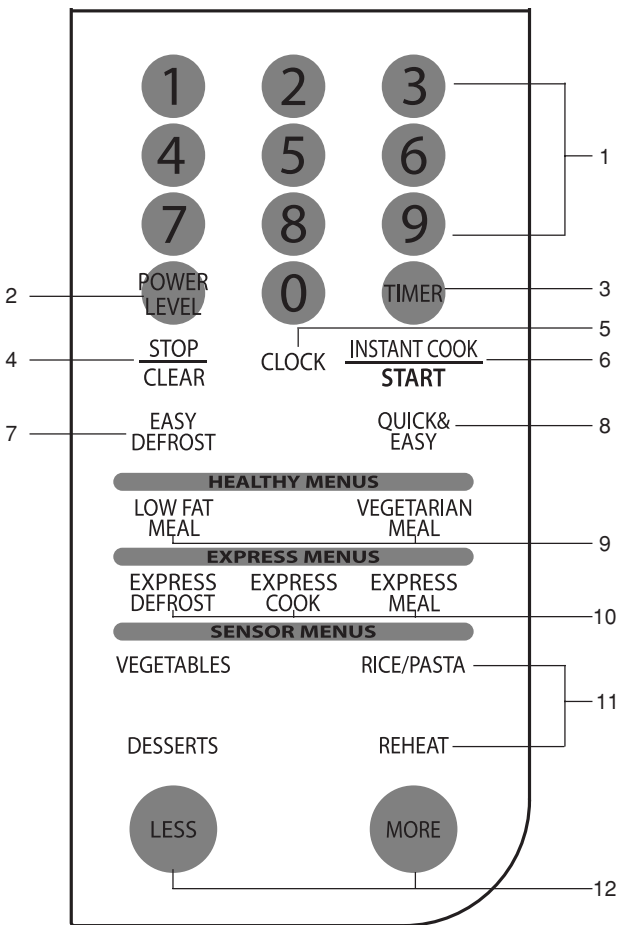

1. NUMBER PADS
Press to enter cooking times, clock time, weight or quantity of food.
2. POWER LEVEL PAD
Press to select microwave power setting. If power is not selected, it automatically defaults to 100%.
3. TIMER PAD
Press to set Timer.
4. STOP/CLEAR PAD
Press to clear during programming.
Press once to stop operation of oven during cooking; press twice to cancel cooking programme.
5. CLOCK PAD
Press to set Clock.
6. INSTANT COOK/START PAD
Press once to cook for 1 minute on 100% or increase by 1 minute multiples each time this pad is pressed during manual cooking. Press to start oven after setting programmes.
7. EASY DEFROST PAD
Press to defrost frozen food by entering quantity.
8. QUICK AND EASY PAD
Press to select Quick and Easy menus.
9. HEALTHY MENU PADS
Press to select "Healthy Menus" menu.
10. EXPRESS MENU PADS
Press to select "Express Menus" menus.
11. SENSOR MENU PADS
Press to select Sensor Cook menus.
12. MORE, LESS PADS
Press to increase/decrease the time in one minute increments during cooking or to alter the cooking result for the automatic operations.

BEFORE OPERATING

* This oven is preset with the INFORMATION GUIDE.

To assist you in operating your oven, useful information will appear on the display.



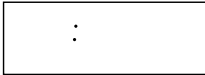

In this manual, the display information guide is abbreviated.

Getting Started

Step	Procedure	Pad Order	Display
1	Plug the oven into a power point and switch on the power. Ensure the oven door is closed.		MICRO-, WAVE, OVEN will be displayed repeatedly.
2	Press the STOP/CLEAR pad so that the oven beeps.		 Only the dots will remain.

Clock Setting

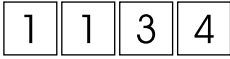
* To enter the present time of day 11:34 (AM or PM).

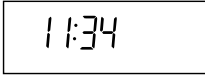
Step	Procedure	Pad Order	Display
1	Press the CLOCK pad.		
2	Enter the correct time of day by pressing the numbers in sequence.		 The dots (:) will flash on and off.
3	Press the CLOCK pad again.		

This is a 12 hour clock. If you attempt to enter an incorrect clock time (eg. 13:45) ERROR will appear in the display. Press the STOP/CLEAR pad and re-enter the time of day (eg. 1:45).

If you wish to know the time of day during the cooking or timer mode, press the CLOCK pad. As long as your finger is pressing the CLOCK pad, the time of day will be displayed.

Stop/Clear

Press the STOP/CLEAR pad once to:

1. Stop the oven temporarily during cooking.
2. Clear if you make a mistake during programming.
3. Clear the message on the display after cooking.

To Cancel a Programme During Cooking

Press the STOP/CLEAR pad twice.

MANUAL OPERATIONS

Microwave Time Cooking

This is a manual cooking feature, first enter the cooking time then the power level. There are five different power levels. You can programme up to 99 minutes, 99 seconds.

Power level	10% (LOW)	30% (MEDIUM LOW)	50% (MEDIUM)	70% (MEDIUM HIGH)	100% (HIGH)
Display	10P	30P	50P	70P	100P
Examples of foods typically cooked on microwave oven power level	Keeping food warm	Defrost Softening butter	Casseroles Seafood	Cakes Muffins Slices	Vegetables Rice/Pasta Fruit

This variable cooking control allows you to select the rate of microwave cooking.

If a power level is not selected, then 100% power is automatically used.

* Suppose you want to time cook for 2 minutes 30 seconds on 100% power.

Step	Procedure	Pad Order	Display
1	Enter desired cooking time.	2 3 0	2:30
2	Press the INSTANT COOK/START pad.	INSTANT COOK START	2:30 COOK The timer begins to count down.

To lower the power press the POWER LEVEL pad until desired power level is displayed.

* Suppose you want to cook Fish Fillets for 10 minutes on 50% power.

Step	Procedure	Pad Order	Display
1	Enter desired cooking time.	1 0 0 0	10:00
2	Select power level by pressing the POWER LEVEL pad as required (for 50% press three times).	POWER LEVEL x 3	50P
3	Press the INSTANT COOK/START pad.	INSTANT COOK START	10:00 COOK The timer begins to count down.

If the door is opened during cooking process, the cooking time in the readout automatically stops. The cooking time starts to count down again when the door is closed and the INSTANT COOK/START pad is pressed.

If you wish to know the power level during cooking, press the POWER LEVEL pad. As long as your finger is touching the POWER LEVEL pad, the power level will be displayed.

If 40 minutes and over on 100% power is entered, the microwave power will be reduced after 40 minutes to avoid overheating.

Sequence Cooking

Your oven can be programmed with up to 3 automatic cooking sequences, automatically switching from one variable power setting to the next.

* Suppose you want to cook for 10 minutes on 50% followed by 5 minutes on 100%.

Step	Procedure	Pad Order	Display
1	Enter desired cooking time. Ex: 10 minutes		
2	Select desired power level by pressing the POWER LEVEL pad (for 50% press three times).		
3	For second sequence, enter desired time for cooking time. If power is not selected the oven will operate at 100% power. Ex: 5 minutes		
4	Press the INSTANT COOK/START pad.		 The timer begins to count down to zero. When it reaches zero, the second sequence will appear and the timer will begin counting down to zero again.

Instant Cook™

For your convenience Sharp's Instant Cook allows you to easily cook for one minute on 100% power.

Instant Cook function is 2 operation methods below and each time the INSTANT COOK/START pad is pressed, the cooking time is increased by 1 minute up to 99minutes.

<Not during cooking>

* Suppose you want to cook 1 minute on 100% power.

Step	Procedure	Pad Order	Display
1	Press the INSTANT COOK/START pad. Within 3 minutes of closing the door, cooking completion or pressing the STOP/CLEAR pad.		 The timer begins to count down.

<During cooking in Manual Operation>

* Suppose you want to cook for 2 minutes 30 seconds on 100% power and add 2 minutes during cooking.

Step	Procedure	Pad Order	Display
1	Enter desired cooking time.	2 3 0	2:30
2	Press the INSTANT COOK/START pad.	INSTANT COOK START	2:30 COOK The timer begins to count down.
			1:18 COOK
3	Press the INSTANT COOK/START pad twice.	INSTANT COOK START x 2	3:16 COOK

AUTOMATIC OPERATIONS

Notes for Automatic Operations

- Wipe off any moisture from the outside of cooking containers and the interior of the oven with a dry cloth or paper towel prior to cooking on SENSOR MENUS.
- After oven is plugged in, wait 2 minutes before using SENSOR MENUS.
- ERROR will be displayed if:
 - more or less than the quantity or weight of foods suggested in the EXPRESS COOK MENU GUIDE or EASY DEFROST MENU GUIDE is programmed when the INSTANT COOK/START pad is pressed. To clear, press the STOP/CLEAR pad and reprogramme.
 - the door is opened or the STOP/CLEAR pad is pressed before the cooking time is displayed. To clear, press the STOP/CLEAR pad and cook manually. Refer to manual cooking charts in RECIPES section.
- When using the automatic features, carefully follow the instructions provided in each MENU GUIDE to achieve the best result. If the instructions are not followed carefully, the food may be overcooked or undercooked or ERROR may be displayed.
- When cooking small quantities of food on SENSOR MENUS, the food may be cooked without displaying any remaining cooking time or requiring any operations during the cooking.
- To defrost foods above or below the weights allowed on the EXPRESS DEFROST MENU GUIDE, use EASY DEFROST or defrost manually.
- Food weighing more or less than the quantity or weight listed in each MENU GUIDE, cook manually. Refer to manual cooking charts in RECIPES section.
- When entering the weight of the food, round off the weight to the nearest 0.1kg(100g). For example, 1.65kg would become 1.7kg.
- To change the final cooking or defrosting result from the standard setting, press the MORE or LESS pad prior to pressing each automatic operation pad to set more or less time. See page 18.
- The final cooking result will vary according to the food condition (e.g. initial temperature, shape, quality). Check the food after cooking and if necessary continue cooking manually.

Express Menu

EXPRESS MENUS will automatically compute the power level and cooking time. EXPRESS MENUS has 3 categories.

EXPRESS DEFROST

1. Fish Fillets
2. Chicken Fillets
3. Sausages / Minced Meat

EXPRESS DEFROST rapidly defrosts 0.5 kg of specific Meat. Follow the instructions provided in the EXPRESS DEFROST MENU GUIDE on page ⑧ of the cooking guides.

* Suppose you want to defrost 0.5 kg of Chicken Fillets.

Step	Procedure	Pad Order	Display
1	Press the EXPRESS DEFROST pad until the desired menu is displayed (for Chicken Fillets press twice).	EXPRESS DEFROST x 2	CHICKEN DEF FILLETS DEF 0.5 KG DEF
2	Press the INSTANT COOK/START pad.	INSTANT COOK START	3:40 COOK DEF The cooking time will begin counting down. The oven will "beep" 4 times and will stop. TURN, OVER, SEPA-, RATE, INTO, PIECES will be displayed repeatedly.
3	Open the door. Turn meat over and separate into pieces. Close the door.		PRESS START will be displayed.
4	Press the INSTANT COOK/START pad.	INSTANT COOK START	1:50 COOK DEF The cooking time will begin counting to zero. When it reaches zero, the oven will "beep". STAND, COVERED, 5 MIN, FOIL will be displayed repeatedly.

NOTE: It is unnecessary to enter weight.





Express Menus

EXPRESS COOK

1. Chilled Roast Beef
2. Frozen Roast Beef
3. Chilled Roast Lamb
4. Frozen Roast Lamb
5. Chilled Roast Chicken
6. Frozen Roast Chicken

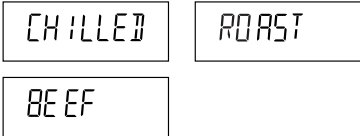
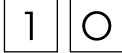
EXPRESS COOK allows you to cook 3 popular menus chilled or frozen. To select a menu, press the EXPRESS COOK pad until the menu of your choice is displayed. Then enter the desired weight using the NUMBER pads. Follow the instructions provided in the EXPRESS COOK MENU GUIDE on pages ⑦ and ⑧ of the cooking guides.

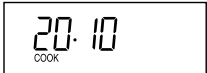
* Suppose you want to use Express Cook to cook 1.0 kg Roast Beef Chilled (Med.).

Step	Procedure	Pad Order	Display
1	Press the EXPRESS COOK pad once to cook Roast Beef Chilled.	 x 1	
2	Press number pads to enter weight. Ex: 1.0 kg		
3	Press the INSTANT COOK/START pad.		 The cooking time will begin counting down. The oven will "beep" 4 times and will stop. TURN, OVER will be displayed repeatedly.
4	Open the door. Turn over meat. Close the door.		PRESS START will be displayed.
5	Press the INSTANT COOK/START pad.		 The cooking time will begin counting to zero. When it reaches zero, the oven will "beep". STAND, COVERED, 5-15 MIN, FOIL will be displayed repeatedly.

Express Menus

**EXPRESS
MEAL**

1. Pasta Dish
2. Risotto
3. Casserole

Express Meal allows you to cook 3 popular menus. Follow the instructions provided in the EXPRESS MEAL RECIPES on pages ④ - ⑥ of the cooking guides.

* Suppose you want to cook Pasta Napolitana (Pasta Dish).

Step	Procedure	Pad Order	Display
1	Press the EXPRESS MEAL pad once to cook Pasta Dish.	EXPRESS MEAL x 1	PASTA DISH
2	Press the INSTANT COOK/START pad.	INSTANT COOK START	26:00 COOK The cooking time will begin counting down. The oven will "beep" 4 times and will stop. STIR will be displayed.
3	Open the door. Stir. Close the door.		PRESS START will be displayed.
4	Press the INSTANT COOK/START pad.	INSTANT COOK START	13:00 COOK The cooking time will begin counting down to zero. When it reaches zero, the oven will "beep". STIR, THEN, STAND, COVERED, 3 MIN will be displayed repeatedly.

Sensor Menu

VEGETABLES

VEGETABLES

1. Fresh-Hard
2. Fresh-Soft
3. Frozen
4. Jacket Potato
5. Fresh Soup

RICE/PASTA

RICE/PASTA

1. White Rice
2. Dry Pasta
3. Fresh Pasta
4. Instant Noodles
5. Frozen Pasta
6. Porridge

DESSERTS

DESSERTS

1. Cake
2. Stewed Fruit
3. Pudding
4. Crunch
5. Muesli Delight











REHEAT

REHEAT

1. Dinner Plate
2. Casserole
3. Soup
4. Pizza
5. Rice
6. Pie

SENSOR MENUS will automatically compute the power level and cooking time. SENSOR MENUS has 4 categories. To select a menu, press the desired SENSOR MENUS pad until the menu of your choice is displayed. Follow the instructions provided in the VEGETABLES MENU GUIDE on pages 9 - 10, RICE/PASTA MENU GUIDE on pages 11 - 12, DESSERTS MENU GUIDE on pages 13, REHEAT MENU GUIDE on pages 14 - 15 of the cooking guide.

* Suppose you want to use Sensor Cook to cook 2 cups of White Rice.

Step	Procedure	Pad Order	Display
1	Press the RICE/PASTA pad once to cook White Rice.	 x 1	 
2	Press the INSTANT COOK/START pad. * When the sensor detects the vapour from the food, the remaining cooking time will appear. (eg. remaining cooking time is 11 min. 40 sec.)		     The cooking time will begin counting down. The oven will "beep" 4 times and will stop. STIR will be displayed.
3	Open the door. Stir the rice. Close the door.		PRESS START will be displayed.
4	Press the INSTANT COOK/START pad.		 The cooking time will begin counting to zero, when it reaches zero, the oven will "beep". STAND, 3-5 MIN, THEN, STIR will be displayed repeatedly.

NOTES: 1. Skip the following procedure unless the oven beeps 4 times and the instruction is shown in the display at step 2*.

2. It is unnecessary to enter quantity.

Healthy Menus

LOW FAT MEAL

VEGETARIAN MEAL

LOW FAT MEAL

1. Mediterranean Chicken
2. Chinese Beef
3. Sesame Prawns
4. Garlic and Chilli Baby Octopus Salad
5. Lemon Fish Fillets

VEGETARIAN MEAL

1. Spinach and Ricotta Cannelloni
2. Vegetables with Hokkien Noodles
3. Spring Vegetable Rice Bake
4. Herbed Jacket Potatoes
5. Vegetable Couscous

HEALTHY MENUS will automatically compute the power level and cooking time. HEALTHY MENUS has 2 categories. To select a menu, press the desired HEALTHY MENUS pad until the menu of your choice is displayed. Follow the instructions provided in the LOW FAT MEAL MENU GUIDE on pages 16 - 17, VEGETARIAN MEAL MENU GUIDE on pages 18 - 19 of the cooking guides.

* Suppose you want to cook Lemon Fish Fillets.

Step	Procedure	Pad Order	Display
1	Press the LOW FAT MEAL pad 5 times to cook Lemon Fish Fillets.	<div style="border: 1px solid black; padding: 2px; display: inline-block;">LOW FAT MEAL</div> x 5	<div style="display: flex; justify-content: space-around;"> <div style="border: 1px solid black; padding: 2px;">LEMON</div> <div style="border: 1px solid black; padding: 2px;">FISH</div> </div> <div style="border: 1px solid black; padding: 2px; margin-top: 5px;">FILLETS</div>
2	Press the INSTANT COOK/START pad.	<div style="border: 1px solid black; padding: 2px; display: inline-block;">INSTANT COOK START</div>	<div style="border: 1px solid black; padding: 5px; text-align: center;"> 6:40 <small>COOK</small> </div> <p>The cooking time will begin counting down. The oven will "beep" 4 times and will stop. TURN, OVER will be displayed repeatedly.</p>
3	Open the door. Turn over fish. Close the door.		PRESS START will be displayed.
4	Press the INSTANT COOK/START pad.	<div style="border: 1px solid black; padding: 2px; display: inline-block;">INSTANT COOK START</div>	<div style="border: 1px solid black; padding: 5px; text-align: center;"> 3:20 <small>COOK</small> </div> <p>The cooking time will begin counting down to zero. When it reaches zero, the oven will "beep". STAND, COVERED, 2 MIN will be displayed repeatedly.</p>

Easy Defrost









EASY DEFROST

1. Minced Meat
2. Steak / Chops
3. Chicken Pieces
4. Poultry
5. Roast Meat
6. Bread

EASY DEFROST will automatically compute the microwave power and defrosting time.

Follow the instructions provided in the EASY DEFROST MENU GUIDE on page 20 of the cooking guides.

* Suppose you want to defrost 2.0 kg of Poultry.

Step	Procedure	Pad Order	Display
1	Press the EASY DEFROST pad until the desired menu is displayed (for Poultry press four times).	 x 4	
2	Press number pads to enter weight.	 	
3	Press the INSTANT COOK/START pad.		 The cooking time will begin counting down. The oven will “beep” 4 times and will stop. TURN, OVER, SHIELD, WARM, PORTION will be displayed repeatedly.
4	Open the door. Turn over meat. Close the door.		PRESS START will be displayed.
5	Press the INSTANT COOK/START pad.		 The cooking time will begin counting to zero. When it reaches zero, the oven will “beep”. STAND, COVERED, 5-50MIN, FOIL will be displayed repeatedly.

Quick and Easy

QUICK & EASY

1. San Choy Bau
2. Chicken Caesar Salad
3. Asian Greens
4. Garlic Prawns
5. Nachos
6. Pecan Fudge

QUICK AND EASY allows you to cook 6 popular recipes. Follow the instructions provided in the QUICK AND EASY RECIPES on pages 21 - 22 of the cooking guides.

* Suppose you want to cook Chicken Caesar Salad.

Step	Procedure	Pad Order	Display
1	Press the QUICK AND EASY pad until the desired menu is displayed (for Chicken Caesar Salad press twice).	<div style="border: 1px solid black; padding: 5px; display: inline-block;"> QUICK & EASY </div> x 2	<div style="display: flex; justify-content: space-around;"> <div style="border: 1px solid black; padding: 5px; display: inline-block;">CHICKEN</div> <div style="border: 1px solid black; padding: 5px; display: inline-block;">CAESAR</div> </div> <div style="border: 1px solid black; padding: 5px; margin-top: 10px; display: inline-block;">SALAD</div>
2	Press the INSTANT COOK/START pad.	<div style="border: 1px solid black; padding: 5px; display: inline-block;"> INSTANT COOK START </div>	<div style="border: 1px solid black; padding: 5px; display: inline-block; text-align: center;"> 6:10 <small>COOK</small> </div> <p>The cooking time will begin counting down. The oven will "beep" 4 times and will stop. TURN, OVER will be displayed repeatedly.</p>
3	Open the door. Turn chicken over. Close the door.		PRESS START will be displayed.
4	Press the INSTANT COOK/START pad.	<div style="border: 1px solid black; padding: 5px; display: inline-block;"> INSTANT COOK START </div>	<div style="border: 1px solid black; padding: 5px; display: inline-block; text-align: center;"> 3:50 <small>COOK</small> </div> <p>The cooking time will begin counting down. The oven will "beep" 4 times and will stop. REMOVE, CHICKEN, ADD, BACON will be displayed repeatedly.</p>
5	Open the door. Remove the chicken. And place bacon following the recipe. Close the door.		PRESS START will be displayed.
6	Press the INSTANT COOK/START pad.	<div style="border: 1px solid black; padding: 5px; display: inline-block;"> INSTANT COOK START </div>	<div style="border: 1px solid black; padding: 5px; display: inline-block; text-align: center;"> 1:30 <small>COOK</small> </div> <p>The cooking time will begin counting to zero. When it reaches zero, the oven will "beep". ADD, CHICKEN, AND, BACON, TO, SALAD, INGREDIENTS, AND, TOSS will be displayed repeatedly.</p>

OTHER CONVENIENT FEATURES

Less/More Setting



The cooking times programmed into the automatic menus are tailored to the most popular tastes. To adjust the cooking time to your individual preference use the “more” or “less” feature to either add (more) or reduce (less) cooking time.

The LESS/MORE pads can be used to adjust the cooking time of the following features

- EXPRESS MENUS
- SENSOR MENUS
- HEALTHY MENUS
- EASY DEFROST
- QUICK AND EASY

* Suppose you want to defrost 2.0 kg Poultry (Easy Defrost) for longer than the standard setting.

Step	Procedure	Pad Order	Display
1	Press the MORE pad.		
2	Press EASY DEFROST pad 4 times to defrost Poultry.	x 4	
3	Press number pads to enter weight.		
4	Press the INSTANT COOK/START pad.		

For EXPRESS MENUS except EXPRESS COOK, HEALTHY MENUS, QUICK AND EASY, SENSOR MENUS select the menu using the desired pad instead of the EASY DEFROST pad, and go to step 4.

Increasing or Decreasing Time During A Cooking Programme

Microwave time can be added or decreased during a manual cooking programme using the “MORE” or “LESS” pads.

* Suppose you want to increase cooking time by 2 minutes during 5 minutes on 50% cooking.







Step	Procedure	Pad Order	Display
1	Enter desired cooking time.		
2	Select power level by pressing the POWER LEVEL pad as required. (for 50% press 3 times)	x 3	
3	Press the INSTANT COOK/START pad.		 The timer starts to count down.
4	Press the MORE pad twice to increase time by 2 minutes.	x 2	

Timer

Use this feature as a general purpose timer. Examples include:
 timing boiled eggs cooked on the stove top.
 timing the recommended standing time of food.

You can enter any time up to 99 minutes, 99 seconds. If you want to cancel the timer during the count down phase simply press STOP/CLEAR and the display will return to the time of day.

* Suppose you want to set the timer for 3 minutes.

Step	Procedure	Pad Order	Display
1	Press the TIMER pad.		ENTER, TIME will be displayed repeatedly.
2	Enter desired time. Ex: 3 minutes	  	
3	Press the INSTANT COOK/START pad .		 The timer begins to count down. When the timer reaches zero, the oven will "beep". END will appear in the display.

Child Lock

If the oven is accidentally started with no food/liquid in the cavity, the oven could be damaged.

To prevent accidents like this, your oven has a "Child Lock" feature that you can set when the oven is not in use.

To set the Child Lock, press the CLOCK pad once, press number pad  and finally press the INSTANT COOK/START pad and hold for 3 seconds. LOCK will appear in the display.

The Control Panel is now locked, each time a pad is pressed, the display will show LOCK.

To unlock the control panel, press the CLOCK pad once, number pad  and the STOP/CLEAR pad. The time of day is displayed and the oven is ready to use.

Demonstration Mode

This feature is mainly for use by retail outlets, and also allows you to practice the key operation.

To demonstrate, press the CLOCK pad once, press number pad  and finally press the INSTANT COOK/START pad and hold for 3 seconds. DEMO, MICRO-, WAVE, OVEN will appear in the display.

Cooking operations can now be demonstrated with no power in the oven. For example, press INSTANT COOK/START pad, and the display will show 1.00 and count down to zero at ten times the speed. When the timer reaches zero, END will appear in the display.

To cancel, press the CLOCK pad once, number pad  and the STOP/CLEAR pad.

Alarm

Your oven has an alarm function. If you leave food in the oven after cooking, the oven will "beep" 3 times and REMOVE FOOD will be displayed in the display after 2 minutes.

If you do not remove the food after cooking completion, the oven will "beep" 3 times after 4 minutes and 6 minutes.

CARE AND CLEANING

Disconnect the power supply cord before cleaning or leave the door open to inactivate the oven.

CLEAN THE OVEN AT REGULAR INTERVALS - Keep the oven clean and remove any food deposits, or it could lead to deterioration of the surface. This could adversely affect the life of the appliance and possibly result in a hazardous situation.

Exterior:

The outside may be cleaned with mild soap and warm water, wipe clean with a damp cloth. Avoid the use of harsh abrasive cleaners. Keep the ventilation openings free of dust.

Door:

Wipe the door and window on both sides, the door seals and adjacent parts frequently with a damp cloth to remove any spills or splatters. Do not use abrasive cleaners.

Touch Control Panel:

Wipe the panel with a cloth dampened slightly with water only.

Do not scrub or use any sort of chemical cleaners. Avoid the use of excess water.

Interior walls:

To clean the interior surfaces, wipe with a soft cloth and warm water. After use wipe the waveguide cover in the oven with a soft damp cloth to remove any food splashes. Built-up splashes may overheat and begin to smoke or catch fire. Do not remove the waveguide cover. **DO NOT USE A COMMERCIAL OVEN CLEANER, ABRASIVE OR HARSH CLEANERS AND SCOURING PADS ON ANY PART OF YOUR MICROWAVE OVEN. NEVER SPRAY OVEN CLEANERS DIRECTLY ONTO ANY PART OF YOUR OVEN.** Avoid using excess water. After cleaning the oven, ensure any water is removed with a soft cloth.

Turntable/Roller Stay:

Wash with mild soapy water and dry thoroughly.

SERVICE CALL CHECK

Please check the following before calling for service:

1. At the power point, switch off the power for 10 seconds and switch back on. Do MICRO-, WAVE and OVEN appear in the display? YES _____ NO _____
2. When the door is opened, does the oven lamp come on? YES _____ NO _____
3. Place one cup of water (approx. 250 ml) in a glass measure in the oven and close the door securely. Oven lamp should go off if door is closed properly. Press the INSTANT COOK/START pad once.
 - A. Does the oven lamp come on? YES _____ NO _____
 - B. Does the cooling fan work? YES _____ NO _____
(Put your hand over the rear ventilation openings.)
 - C. Does the turntable rotate? YES _____ NO _____
(The turntable can rotate clockwise or counterclockwise. This is quite normal.)
 - D. After one minute, did an audible signal sound and COOK indicator go off? YES _____ NO _____
 - E. Is the water inside the oven hot? YES _____ NO _____

If "NO" is the answer to any of the above questions, please check your wall socket and the fuse in your meter box.

If both the wall socket and the fuse are functioning properly, CONTACT YOUR NEAREST SERVICE CENTRE APPROVED BY SHARP.

NOTE: 1. If time in the display is counting down rapidly, check Demonstration Mode. (See page 19 for detail.)
2. If you cook the food over 40 minutes on 100% power, the microwave power will be automatically reduced to avoid overcooking.

SPECIFICATIONS

AC Line Voltage	Single phase 230-240V, 50Hz
AC Power Required	1.60 kW
Output Power	1100 W* (IEC test procedure)
Microwave Frequency	2450 MHz (Class B/Group 2)**
Outside Dimensions (WxHxD)	550mm x 315mm x 446mm
Depth with the door open	860mm
Cooking Uniformity	Turntable (ø360mm tray) system
Weight	Approx. 18 kg

* When tested in accordance with AS/NZS 2895.1.2004

** This is the classification of ISM (Industrial, Scientific and Medical) equipment described in the International Standard CISPR11.

HINTS

- Always place the stems of vegetables – e.g. cauliflower, broccoli – toward the outside of the dish. The stems are tougher than the flower, so this will ensure even cooking.
- Ice-cream containers were made for freezing food and are not suitable for use in a microwave oven.
- Remember: When melting chocolate in the microwave oven, it holds its shape until stirred. Heat for 2-2½ minutes per 100 g on MEDIUM. DO NOT COVER.
- Jams and chutneys are great when made in the microwave, as they retain their colour and flavour. As cooking time is so short, less evaporation occurs. Therefore pectin or a jam setting agent is required to make jam set.
- To obtain more juice from oranges, lemons or limes, prick skin, microwave 30 seconds on HIGH and stand 2 minutes before squeezing.
- Warm jam for a quick glaze. Heat 2-3 tablespoons for 30 seconds on HIGH; strain if necessary while hot.
- Soften cream cheese for dips or beating by removing foil wrapper and cooking for 1 minute on MEDIUM LOW.
- To melt marshmallows, place 100 g in a large bowl. Cook for 30 seconds on HIGH.
- To dissolve gelatine, mix 1 teaspoon gelatine with 2 tablespoons water and cook for 20-30 seconds on HIGH. Stir well.
- To blanch almonds place 100 g in a bowl with 1 cup of water. Cook for 5 minutes on HIGH.
- If brown sugar becomes hard, simply soften in the microwave oven. Place a cup at a time in a bowl with a slice of bread. Cover with plastic wrap and cook for 40 seconds on HIGH.
- Soften 6-8 honey-snap biscuits for 30 seconds on HIGH. Shape into base of patty dish for quick tartlet cases.
- Place a chocolate after-dinner mint on top of 6 patty cakes; arrange cakes evenly on turntable. Cook about 50-60 seconds on HIGH, or until chocolate is soft. Gently spread chocolate mint evenly over patty cake for a quick icing.
- To soften honey, remove metal lid from jar and microwave on HIGH for 30 seconds.
- Stuffed mushrooms are a terrific idea. Provided the filling is cooked, twelve mushrooms placed on a layer of paper towel will take approximately 3 minutes to heat on HIGH.
- To remove odours, place 1-litre water with slice of lemon or 1 teaspoon vanilla essence in the microwave. Cook for 20 minutes on HIGH.
- As microwave cooking time is so quick, food should be seasoned to taste with herbs and spices after cooking.
- To peel a tomato, pierce the skin with a fork 3-4 times. Place on a rack and cook for 45-60 seconds on HIGH. Stand for 3 minutes before peeling.
- Lightly prick the skin of chicken before cooking. This prevents the loud popping noises.
- Peeling garlic is made easier by placing a clove in the microwave for 10 seconds on HIGH.
- Pierce the skin of chicken livers with a fork before cooking to prevent popping of the internal fat. Cover with paper towel when cooking.
- The flavour of wine in food is highlighted with the short microwave cooking time, so adjust the quantity to your taste.
- Tomato sauce can be warmed for 30 seconds on HIGH to give it a pouring consistency. (ensure lid is removed.)
- When cooking sauces in the microwave use less liquid: the absence of direct heat means sauces do not reduce as much as stovetop-prepared sauces.
- Rice and pasta cook well in small quantities. Use a large container to prevent boiling over.
- FOIL. Contrary to popular belief, foil can be used in the microwave – for shielding, not covering. It must not come in contact with the walls of the microwave. Foil directs microwave energy away from delicate or thin areas of food, toward areas that need more cooking. It is essential for even defrosting. Place foil over the thawed sections, allowing the frozen portions to continue defrosting.
- To enhance the colour and flavour when roasting chicken, mix some brown sugar, honey and a little soy sauce together and brush both sides of poultry before and during cooking.
- To blanch vegetables for freezing, place 150 g of vegetables in a dish with 1 tablespoon of water. Cover and cook on HIGH for 1/3 of the usual cooking time. After cooking, immerse immediately in iced water, package, label, and freeze for up to 3 months.
- Do not add salt to vegetables before cooking, as salt draws out the moisture and causes vegetables to toughen.

DRIED MUSHROOMS

Place in a bowl with 2 cups of water and heat, slowly, 8-10 minutes on LOW.

COMMONLY ASKED QUESTIONS AND ANSWERS

MICROWAVES COOK FROM THE INSIDE OUT. They certainly do not. Microwaves penetrate foods from the outside to a depth of about 2.5 cm. Small foods, under 5 cm in diameter, are penetrated to the centre from all sides. With large foods, energy creates heat in the outer layer; then the heat moves to the centre by conduction, as it does conventionally. A few foods may appear to cook more on the inside. One example is an egg. Energy penetrates to the centre, where the fatty yolk becomes hotter than the white, and cooks quicker.

YOU CAN'T USE METAL IN A MICROWAVE OVEN.

False. Metal reflects microwaves; the oven itself is made of metal so microwave energy can't escape. Inside the oven, metal slows cooking because it keeps energy from reaching parts of the food. You can use the reflective properties of metal to protect foods which might overcook in some areas.

DISHES DON'T GET HOT IN A MICROWAVE OVEN.

Keep your oven mitts handy. A microwave-safe utensil will not be heated by microwave energy, but it will become hot from contact with hot food. Heat tends to equalise. A warm object heats the air around it, like a radiator in a cool room. When food becomes hot, some of this heat is transferred to the dish.

POINTS TO REMEMBER

As a general guide:

HIGH – is ideal for vegetables, fruit, soup, beverages, bacon and sauces.

MEDIUM HIGH – for roasting lamb, roasting chicken and fish fillets.

MEDIUM – is for roasting beef, pork and simmering; great for casseroles or stews and cooking seafood.

MEDIUM LOW – allows you to defrost.

LOW – is used to keep foods warm once they are cooked.

- The more food in the microwave oven, the longer it takes to cook.
- Reduce liquids in a microwave recipe because there is not as much evaporation, due to the shorter cooking time.
- Reduce seasonings slightly because flavours will be unbalanced by quantity of liquid. Do not add salt until the end of the cooking process.
- Microwaves cook from the outside to the centre, so when arranging foods always place the thicker or more dense portions of food at the outside, with the thinner, less-dense pieces on the inside.
- Foil can be used in the microwave oven successfully.

Just remember two rules:

(a) There must be at least half of the food exposed to the microwaves.

(b) Do not let the foil touch the sides of the oven.

Use foil to shield thinner parts of food when defrosting, to prevent over-cooking and drying out.

- All food continues to cook after it leaves the microwave oven because the heat is stored in the food and not in the oven.

Standing time required will vary according to the volume and density of food.

e.g. Fish and vegetables – 1-5 minutes

Cakes – 3-10 minutes

Roasts – 5-15 minutes

Cover foods with a lid or foil when standing.

- When reheating foods always cover with a lid, plastic wrap or paper towel to prevent foods from drying out. Reheat on **MEDIUM** for best results.
- Always pierce food that has a membrane – for example eggs, tomatoes, potatoes and kidneys.
- Remember to cover vegetables with a lid or plastic wrap when cooking.

GLOSSARY OF TERMS

SPOON MEASURES

1 tablespoon	=	20 mL
1 teaspoon	=	5 mL
1/2 teaspoon	=	2.5 mL
1/4 teaspoon	=	1.25 mL

LIQUID MEASURES

Cups	Metric	Imperial
1 cup	= 250 mL	= 8 fl. oz.
1/2 cup	= 125 mL	= 4 fl. oz.
1/3 cup	= 80 mL	= 2.5 fl. oz.
1/4 cup	= 60 mL	= 2 fl. oz.

CUP MEASURES

	Metric	Imperial
1 cup flour	140 g	4 1/2 oz.
1 cup sugar	250 g	8 oz.
1 cup brown sugar	185 g	6 oz.
1 cup icing sugar	185 g	6 oz.
1 cup butter/margarine	250 g	8 oz.
1 cup honey/golden syrup	375 g	12 oz.
1 cup fresh breadcrumbs	60 g	2 oz.
1 cup crushed biscuits	125 g	4 oz.
1 cup uncooked rice	220 g	7 oz.
1 cup mixed fruit	185 g	6 oz.
1 cup chopped nuts	125 g	4 oz.
1 cup coconut	90 g	3 oz.

DRY INGREDIENTS

Metric		Imperial
15 g	=	1/2 oz.
30 g	=	1 oz.
60 g	=	2 oz.
90 g	=	3 oz.
125 g	=	4 oz.
185 g	=	6 oz.
250 g	=	8 oz.
500 g	=	1 lb.
1000 g (1 kg)	=	2 lb.

NOTE

- Recipes in this book use standard metric equipment approved by the Australian Standards Association.
- All spoon and cup measures are level.
- All recipes in this book that include eggs require 55 g unless otherwise specified.

GENERAL INFORMATION

DEFROSTING

Thawing food, especially meats, using the microwave oven is not only faster than any other method but it can also give better results.

Once frozen meat is thawed, it begins to lose its juices.

With a microwave oven you can thaw meat just before you plan to cook it, thus preserving the quality.

Microwave thawing doesn't mean a lot of fuss, but some attention is needed to make sure that parts of food do not start to cook before the centre is thawed. MEDIUM LOW is fast enough to be convenient but gentle enough to give good results.

POULTRY

Start thawing poultry breast-side down; shield warm areas and turn over halfway through defrosting. Let poultry stand 30 to 60 minutes after thawing, until giblets and neck can be removed and breast meat under wings is completely thawed.

CUTS OF MEAT

Break up or separate minced beef, cubed meat, chicken pieces or fish fillets after one-third of thawing time. Remove any thawed pieces. Place remainder in baking dish to complete thawing. Turn over roasts, steaks, chops or chicken. Separate as soon as possible.

JOINTS

Turn over large roasts halfway through defrosting. As you turn, touch the meat to find warm areas and shield these with small pieces of foil. Let roasts stand 30 to 45 minutes after defrosting time. Thaw meats and poultry only until they can be pierced in the centre with a skewer. Surface or cavity should feel cool but not icy. Cook as soon as possible to prevent loss of juices.

REHEATING

Foods reheated in the microwave oven taste freshly cooked, not reheated. Suit the power level to the food. A bowl of leftover vegetables can be reheated on HIGH,

while lasagne, which contains sensitive cheese and cannot be stirred, should be reheated on MEDIUM HIGH or MEDIUM.

CASSEROLES

Cover dish tightly with plastic wrap or a lid. Stir several times during reheating, especially if casserole has been refrigerated. If casserole cannot be stirred, reheat on MEDIUM.

MEATS

Medium to thin slices reheat best. Cover meat with sauce or gravy. Cover with microwave plastic wrap to hold in heat. Reheat on MEDIUM.

PLATES OF FOOD

Arrange food with thickest parts of meat and bulky vegetables to outside of the plate. Place quick-to-heat foods in the centre. Cover with microwave plastic wrap. Reheat on MEDIUM.

VEGETABLES

Wrap large, whole vegetables in microwave plastic wrap. Cover dishes of vegetables and stir during reheating, if possible.

TOASTING

ALMONDS

Place 100 g almonds in a glass dish; cook for 3-3 1/2 minutes on HIGH, or until golden brown. Stir almonds every minute during cooking.

SESAME SEEDS

Place 1/4 cup sesame seeds in a glass bowl; cook for 2-3 minutes on HIGH, or until golden. Stir every minute.

RECONSTITUTING DRIED FOODS

DRIED FRUITS

Place 1 cup of fruit in a bowl, cover with cold water, and cook for 4 1/2-5 minutes on HIGH. Stand covered for 5 minutes before using.

REHEATING CONVENIENCE – FOOD CHART DEFROSTING CONVENIENCE

FOOD	WEIGHT	COOKING TIME AND POWER LEVEL	SPECIAL INSTRUCTIONS	STANDING TIME
Beverage (room temp.) 250 mL per cup	1 cup 2 cups	1½ minutes on HIGH 3 minutes on HIGH	Stir after heating.	—
Canned Food (room temp.) (e.g. Spaghetti, Baked Beans)	1 cup 2 cups	4-5½ minutes on MEDIUM 8-10 minutes on MEDIUM	Place food in bowl. Cover with plastic wrap or lid. Stir halfway.	1-3 minutes
Canned Soup (room temp.) 250 mL per cup	1 cup 2 cups	2-2½ minutes on HIGH 3-3½ minutes on HIGH	Stir halfway through cooking. Stir after heating.	—
Meat Pie (refrigerated) Individual 180 g each	1 pie 4 pies	2½-4 minutes on MEDIUM 9½ minutes on MEDIUM	Place directly on turntable, face side down. Cover with paper towel. Turn over halfway.	1-3 minutes
Frozen Pasta Dinners (e.g. Lasagne)	300-500 g 500-750 g	3½-5 minutes on HIGH, followed by 4-5 minutes on MEDIUM 4½-6 minutes on HIGH, followed by 8½-10 minutes on MEDIUM	Remove from foil container. Place in a dish same size. Cover with plastic wrap or lid. Allow to stand.	2-3 minutes
Pizza (refrigerated) 100 g per slice	1 slice 2 slices	1-1½ minutes on MEDIUM 2-2½ minutes on MEDIUM	Place on paper towel. Place directly on turntable. Allow to stand.	—
Dinner Plate (refrigerated) 350 g-400 g per serve	1 serve	5½-6 minutes on MEDIUM	Slice potato. Cover plate with plastic wrap. Place directly on turntable. Allow to stand.	2 minutes
Casserole (refrigerated) 250 g per serve	1 serve 2 serves	4-5½ minutes on MEDIUM 8-10 minutes on MEDIUM	Place in a bowl, cover with plastic wrap. Place directly on turntable. Stir halfway. Allow to stand, then stir.	1-3 minutes
Croissants (frozen)	1 2	35-45 seconds on MEDIUM LOW 60-70 seconds on MEDIUM LOW	Place between paper towels. Place directly on the turntable.	—
Fruit Pie whole (frozen)	600 g	4-5 minutes on MEDIUM HIGH followed by 5 minutes on MEDIUM LOW	Remove from foil container. Place on a roasting rack. Allow to stand.	2-3 minutes
Fruit Pie individual (frozen) 135 g each	1 2	1½-2 minutes on MEDIUM LOW 2½-3 minutes on MEDIUM LOW	Remove from foil container. Place directly on the turntable. Allow to stand.	1-2 minutes
Pecan Pie whole (frozen)	1 kg	3-3½ minutes on MEDIUM HIGH	Remove from foil container. Place on a plate lined with paper towel. Allow to stand.	2-3 minutes
Jam Donuts (frozen)	2 4	1½-2 minutes on MEDIUM LOW 3-3½ minutes on MEDIUM LOW	Place directly on turntable. Turn over halfway through defrosting.	—
Danish Pastry whole (frozen)	400 g	2-3 minutes on MEDIUM HIGH followed by 2-2½ minutes on MEDIUM LOW	Remove from foil container. Place on dinner plate. Allow to stand.	2-3 minutes

NOTE: Room Temperature +20°C
Refrigerator Temperature +3°C
Frozen Temperature -18°C

FROZEN VEGETABLE CHART

1. Place vegetables in a dish. Cover with a lid or plastic wrap.
2. Stir halfway through cooking.
3. Allow to stand 1-3 minutes before serving.

VEGETABLE	WEIGHT	MICROWAVE TIME AT HIGH (100%)	SPECIAL PROCEDURES
Asparagus	500 g	6-7 minutes	
Beans (green, cut)	500 g	6 ¹ / ₂ -7 minutes	
Broccoli	500 g	6 ¹ / ₂ -7 minutes	Break apart as soon as possible. Arrange with flower towards the centre.
Brussels sprouts	500 g	6 ¹ / ₂ -7 minutes	
Carrots (whole)	500 g	6 ¹ / ₂ -7 minutes	
Carrots (sliced)	500 g	6 ¹ / ₂ -7 minutes	
Cauliflower	500 g	6 ¹ / ₂ -7 minutes	Break apart as soon as possible. Arrange with flower towards the centre.
Corn (on cob)	4 pieces (500 g)	6 ¹ / ₂ -7 minutes	
(kernel)	500 g	6 ¹ / ₂ -7 minutes	
Peas (green)	500 g	6 ¹ / ₂ -7 minutes	
Spinach	250 g	4-4 ¹ / ₂ minutes	
Mixed Vegetables	500 g	6 ¹ / ₂ -7 minutes	Break apart as soon as possible.

RICE AND PASTA COOKING CHART

FOOD	OTHER INGREDIENTS	COOKING TIME
1 cup white rice	2 cups hot tap water	10-12 minutes on HIGH
1 cup brown rice	2 ¹ / ₂ cups hot tap water	20-24 minutes on HIGH
1 cup macaroni	4 cups boiling water	10-12 minutes on HIGH
250 g spaghetti	4 cups boiling water	12-14 minutes on HIGH
250 g fettuccine	4 cups boiling water	10-12 minutes on HIGH
¹ / ₃ cup quick-cooking oats	³ / ₄ cup cold tap water or milk	3-4 minutes on HIGH
1 cup quick-cooking oats	2 ¹ / ₄ cups cold tap water or milk	4 ³ / ₄ -5 ¹ / ₂ minutes on HIGH

Procedure:

Place rice/pasta/oats in a large bowl with water. Cook uncovered, stirring twice during cooking. Allow to stand 2 minutes.

GUIDE TO COOKING EGGS

SCRAMBLED EGG GUIDE

Place butter, eggs and milk in a small bowl. Beat with a fork until well combined. Cook, uncovered, stirring halfway through cooking.

Egg(s)	Butter	Milk	Cook MEDIUM HIGH (70%)
1	1 tsp.	1 tbsp.	1-1 ¹ / ₂ min.
2	2 tsp.	1 tbsp.	1 ¹ / ₂ -2 min.
3	1 tbsp.	2 tbsp.	2 ¹ / ₂ -3 min.
4	1 tbsp.	¹ / ₄ cup	3-3 ¹ / ₂ min.

FRESH VEGETABLE CHART

VEGETABLE	AMOUNT	MICROWAVE TIME AT HIGH (100%)	COOKING PROCEDURE
Asparagus	500 g	3-4 minutes	Wash and place in a freezer bag. Allow to stand 3 minutes before serving.
Beans	500 g	4½-5 minutes	Cut into 4 cm pieces. Place in a dish with 1 tablespoon water. Cook covered. Allow to stand 3 minutes before serving.
Broccoli	500 g	4½-5 minutes	Cut into uniform florets. Arrange with flower towards centre. Cook covered. Allow to stand 3 minutes before serving.
Brussels sprouts	500 g	3½-4 minutes	Arrange in a 23 cm flan dish. Arrange with stalk towards outside. Cook covered. Allow to stand 3 minutes before serving.
Cabbage	500 g	3½-4 minutes	Shred and cook in a dish with 2 tablespoons water. Cook covered. Allow to stand 3 minutes before serving.
Carrots	500 g	4½-5 minutes	Arrange in a dish with 1 tablespoon water. Cook covered. Allow to stand 3 minutes before serving.
Cauliflower	500 g	4½-5 minutes	Cut into uniform florets. Arrange with flower towards centre, with 1 tablespoon water. Cook covered. Allow to stand 3 minutes before serving.
Chokos	500 g (2)	5½-6½ minutes	Cut into quarters. Place in a 20 cm pie plate with 1 tablespoon of water. Cook covered. Allow to stand 3 minutes before serving.
Corn (on cob)	500 g (2)	4½-6½ minutes	Rinse corn under cold water. Place corn in husk directly onto turntable. Turn over during cooking. Allow to stand 3 minutes before serving.
	1 kg (4)	14-15 minutes	Rinse corn under cold water. Place corn in husk directly onto turntable. Turn over during cooking. Allow to stand 5 minutes before serving.
Eggplant	500 g	3½-4 minutes	Cut into 2 cm cubes. Place in a dish with 2 tablespoons water. Cook covered. Allow to stand 3 minutes before serving.
Mushrooms	500 g	3½-4 minutes	Sliced or whole. Place in a dish with 2 teaspoons butter. Allow to stand 3 minutes before serving.

VEGETABLE	AMOUNT	MICROWAVE TIME AT HIGH (100%)	COOKING PROCEDURE
Peas - Green	500 g	3-4 minutes	Cook in a dish with 1 teaspoon sugar and 1 tablespoon water. Cook covered. Allow to stand 3 minutes before serving.
- Snow	500 g	2½-3 minutes	Remove string from pod. Cook in a dish with 1 tablespoon water. Cook covered. Allow to stand 3 minutes before serving.
Potatoes (jacket)	2 medium 4 small	3½-4½ minutes	Pierce skin with a fork. Place on turntable. Turn over halfway through cooking. Allow to stand wrapped in foil 3 minutes.
(baked)	2 medium 4 small	4½-5 minutes	Peel and quarter potatoes. Cook in a dish with ⅓ cup water. Cook covered. Allow to stand 3 minutes before serving.
Pumpkin	500 g	4½-5 minutes	Peel and cut into serving-size pieces. Place in a dish and cook covered. Allow to stand 3 minutes before serving.
Spinach	500 g	4-6 minutes	Wash and shred. Cook, covered, in a dish with 2 tablespoons water. Allow to stand 3 minutes before serving.
Squash	500 g	3½-4 minutes	Wash and place in a dish with 1 tablespoon of water. Pierce whole squash with a fork. Cook covered. Allow to stand 3 minutes before serving.
Sweet Potato	500 g 1 kg	5-6 minutes 11-12 minutes	Peel and quarter potatoes. Cut in half and then into 1 cm thick slices. Allow to stand 3-5 minutes before serving.
Tomatoes	500 g	2½-3 minutes	Cut into quarters. Place in a dish. Season and cook covered. Allow to stand 3 minutes before serving.
Zucchini	500 g	3½-4 minutes	Cut into uniform-size pieces. Place in a dish with 1 tablespoon water and 1 tablespoon butter. Cook covered. Allow to stand 3 minutes before serving.
Vegetables (canned)	500 g	4-5 minutes	Drain, reserving 2 tablespoons liquid. Place vegetables and reserved liquid in a dish and cook covered. Allow to stand 3 minutes before serving.

MICROWAVE OVEN ROASTING CHART

FOOD	COOKING TIME AND POWER LEVEL	INSTRUCTIONS	STANDING TIME
BEEF Rare Medium Well done	24-27 minutes/kg on MEDIUM 28-31 minutes/kg on MEDIUM 34-37 minutes/kg on MEDIUM	Tie meat with string. Season with cracked pepper. Place fat-side down on a Rack. Turn over halfway through cooking. Stand covered with foil before carving.	10-15 minutes
VEAL Well done	33-35 minutes/kg on MEDIUM	Tie meat with string. Place on a rack. Brush with melted butter. Turn over halfway through cooking. Stand covered with foil before carving.	5-10 minutes
PORK Well done	29-31 minutes/kg on MEDIUM	Brush rind with oil and sprinkle with salt. Place on a rack. Turn over halfway through cooking. Stand covered with foil before carving.	10-15 minutes
LAMB Medium Well done	17-21 minutes/kg on MEDIUM HIGH 22-25 minutes/kg on MEDIUM HIGH	Season with 'Season All' or as desired. Place fat-side down on a rack. Turn over halfway through cooking. Stand covered with foil before carving.	10-15 minutes
CHICKEN Whole	16-21 minutes/kg on MEDIUM HIGH	Brush with melted butter. Season as desired. Place chicken breast-side down on a rack. Turn over and shield wings and legs halfway through cooking. Stand covered with foil before carving.	10-15 minutes
CHICKEN Pieces	12-13 minutes/500 g on MEDIUM	Season as desired. Place chicken skin-side down on a rack. Turn over halfway through cooking.	10-15 minutes
TURKEY Whole	15-17 minutes/500 g on MEDIUM	Truss turkey. Place breast-side down on a rack. Turn over halfway through cooking and shield wings and legs. Baste with melted butter 2-3 times during cooking. Stand covered with foil before carving.	10-15 minutes
DUCK	12-14 minutes/500 g on MEDIUM	Place duck breast-side down on a rack. Pierce skin to drain excess fat. Turn over halfway through cooking. Stand covered with foil before carving.	10-15 minutes

CHARTS

DEFROSTING FROZEN FOODS

Procedure:

1. Remove wrapping from meat.
2. Place frozen meat on a defrost rack. Shield.
3. Defrost using MEDIUM LOW/DEFROST power level (30%).
4. Halfway through defrosting, remove any defrosted portions, e.g. steak, mince.
Turn over and shield. Continue defrosting.

DEFROSTING TIMES AND TECHNIQUES FOR MEAT AND POULTRY

CUT	MICROWAVE TIME	STANDING TIME
BEEF (Roast)	10-12 minutes/500 g	10-15 minutes
Steaks	6-8 minutes/500 g	5-10 minutes
Minced Beef	8-10 minutes/500 g	5-10 minutes
PORK (Roast)	8-10 minutes/500 g	10-15 minutes
Chops	5-7 minutes/500 g	5-10 minutes
Ribs	7-9 minutes/500 g	5-10 minutes
Minced Pork	9-11 minutes/500 g	5-10 minutes
LAMB (Roast)	8-10 minutes/500 g	10-15 minutes
Shoulder	7-9 minutes/500 g	10-15 minutes
Chops	6 ¹ / ₂ -7 ¹ / ₂ minutes/500 g	5-10 minutes
POULTRY		
Turkey (Whole)	8-10 minutes/500 g	20-30 minutes
Chicken (Whole)	8-9 minutes/500 g	10-15 minutes
Pieces	8-12 minutes/500 g	10-15 minutes
Duck	8-10 minutes/500 g	10-15 minutes

DEFROSTING TIMES AND TECHNIQUES FOR SEAFOOD, BREAD AND PIES

SEAFOOD	MICROWAVE TIME	STANDING TIME	PROCEDURES
Whole Fish	4-6 minutes/500 g	5 minutes	Shield head and tail with foil. Separate and rearrange halfway through defrosting.
Scallops	6-8 minutes/500 g	2-3 minutes	Separate as soon as possible.
Prawns	4-6 minutes/500 g	2-3 minutes	Separate as soon as possible.

BREAD	MICROWAVE TIME	PROCEDURES
2 slices	20-25 seconds	Place between paper towel directly on turntable.
4 slices	40-45 seconds	
6 slices	50-60 seconds	
Bread Rolls	30-35 seconds per roll	

PIES	MICROWAVE TIME	PROCEDURES
Individual	3-4 minutes	Remove from packaging. Place between paper towel on a rack. Turn over halfway. Allow to stand 3-5 minutes before reheating.
Whole	7-8 minutes	

DESSERTS

AUSTRALIAN FRUIT CAKE

Serves 4-6

1 kg mixed fruit
1 cup brown sugar
250 g butter, chopped
2 tablespoons brandy
4 eggs, lightly beaten
2 teaspoons parisienne essence

1 cup plain flour, sifted
1 teaspoon baking powder
1/2 teaspoon nutmeg
1 teaspoon cinnamon
2 tablespoons brandy, extra

1. Combine the first 4 ingredients in a large microwave safe glass bowl. Cover and cook for 4 minutes on HIGH, stirring once. Allow to cool slightly.
2. Stir in eggs and parisienne essence, followed by dry ingredients.
3. Pour into a greased 20 cm microwave safe cake container.
4. Cook for 5 minutes on HIGH.
5. Using a 3 cm foil strip, place around the outside of cake plastic container. (This will prevent the outside from overcooking before the centre is cooked.)
6. Cook a further 5 minutes on HIGH.
7. Stand for 10 minutes before turning out.
8. Pour over extra brandy. Decorate with extra glacé fruits if desired.

CHOCOLATE CAKE

2 cups sugar
3/4 cup cocoa
1 teaspoon baking powder
1 1/2 cups milk

1/2 cup oil
1 3/4 cups plain flour
2 eggs
2 teaspoons vanilla

ICING

125 g butter
1 cup icing sugar
1 dessert spoon rum

125 g philadelphia cheese
2 dessert spoons cocoa

1. Combine all ingredients together in a large bowl.
2. Using an electric hand mixer, beat together for 3 minutes on HIGH.
3. Pour into a greased microwave safe gugelhopf container.
4. Cook for 18-23 minutes on MEDIUM. Allow to stand 5-10 minutes before turning out.
5. Allow to cool before icing.

ICING

1. Beat ingredients together till light and creamy.

BREAD AND BUTTER PUDDING

Serves 4-6

4 slices multigrain bread,
crusts removed
butter
3 tablespoons caster sugar
1/4 cup sultanas

2 1/2 cups milk
1/2 teaspoon vanilla essence
4 eggs, lightly beaten
3 teaspoons brown sugar
1/4 teaspoon nutmeg

1. Spread bread with butter and cut into 2 cm cubes.
2. Place bread, sugar and sultanas in a 2-litre microwave safe casserole dish.
3. Place milk and vanilla essence into a microwave safe jug, cook for 3 minutes on HIGH.
4. Gradually whisk the warmed milk into eggs. Cook for 3-4 minutes on HIGH, stirring occasionally.
5. Pour over bread mixture.
6. Sprinkle with brown sugar and nutmeg.
7. Cook for 15-20 minutes on MEDIUM LOW.
8. Allow to stand for 5-10 minutes before serving.

CARAMEL RICE PUDDING

Serves 4-6

1 cup rice
3 cups hot water
400 g can condensed milk

20 g butter
1 tablespoon lemon juice
cinnamon sugar

1. Place rice and water in a large microwave safe glass bowl. Cook for 10 minutes on HIGH, or until tender. Stir halfway. Drain.
2. Mix condensed milk and butter together. Cook for 4-6 minutes on HIGH, stirring every 30 seconds. (Caramel will boil over if not stirred.)
3. Mix caramel into rice and sprinkle with cinnamon sugar.

CHOCOLATE MOUSSE

Serves 4

200 g cooking chocolate
2 tablespoons water
2 tablespoons rum
1/4 cup caster sugar

3 egg whites
300 mL carton thickened cream
extra cream for decoration
30 g chocolate, grated

1. Place chocolate, water and rum in a large microwave safe glass bowl. Melt for 1 minute on HIGH, stirring halfway. Stir in sugar.
2. Allow mixture to cool, then whip until aerated.
3. Beat egg whites until stiff peaks form.
4. Whip the cream until thick but not stiff. Fold cream and beaten egg whites into chocolate mixture.
5. Divide mixture evenly between four dessert glasses. Refrigerate until set.
6. Serve decorated with cream and chocolate shavings.

POTATO, AVOCADO AND ONION SALAD Serves 6

1 kg small new potatoes
1 large onion, sliced into rings
1 tablespoon caster sugar
20 g butter
1/2 cup mayonnaise

150 mL sour cream
black pepper
1 large avocado, cubed
chives, for garnish

1. Cut unpeeled potatoes in half. Place in a large microwave safe glass bowl and cover with water. Cook covered for 14-16 minutes on HIGH (potatoes should be tender but holding their shape). Drain.
2. Place onion rings, caster sugar and butter in a microwave safe dish. Cook for 4-6 minutes on HIGH, stirring twice.
3. Combine mayonnaise, sour cream and black pepper. Pour over potatoes.
4. Toss in onions and avocado; sprinkle with chives.

STUFFED BAKED POTATOES Serves 4

4 large potatoes
1/4 cup milk
1/4 cup cream
1/2 cup grated cheddar cheese

30 g butter
2 teaspoons dried parsley flakes
1/4 teaspoon dry mustard
paprika

1. Pierce potatoes with a fork; place on turntable. Cook for 10-12 minutes on HIGH. Stand in foil for 5 minutes.
2. Cut a thin slice from the top of each potato; scoop out cooked potato with a spoon, leaving a thin shell.
3. Stir milk, cream, half the cheese, butter, parsley, mustard and potato. Mix well until no lumps remain.
4. Spoon mixture into each potato shell. Place on a plate.
5. Sprinkle with remaining cheese and paprika. Cook for 4-5 minutes on HIGH, until cheese is melted.

PUMPKIN SALAD Serves 6-8

1 kg pumpkin, peeled and cubed
2 tablespoons water
3/4 cup walnuts
6 green onions, chopped

1 tablespoon finely chopped fresh parsley
1/2 teaspoon nutmeg
ground black pepper
1 cup mayonnaise

1. Place pumpkin in large microwave safe glass bowl, add 2 tablespoons of water, cover and cook for 10-12 minutes on HIGH or until pumpkin is just cooked, but still firm. Stir halfway through cooking
2. Refresh by running cold water over pumpkin. Drain and chill.
3. Mix walnuts, green onions, parsley, nutmeg and pepper with mayonnaise.
4. Fold mayonnaise mixture gently into the pumpkin. Serve chilled.

HONEY GINGERED VEGETABLES Serves 6

2 teaspoons grated ginger
2 tablespoons honey
1 tablespoon soy sauce
2 teaspoons lemon juice
500 g butternut pumpkin, peeled and thinly sliced
1 cup frozen beans
2 zucchinis, sliced
1 tablespoon sesame seeds

1. In a large microwave safe glass bowl, add honey, soy sauce and lemon juice, stir and cook for 1 minute on HIGH.
2. Add pumpkin and cook covered 4-6 minutes on HIGH, until just tender.
3. Stir in beans and zucchini, cook covered a further 3-4 minutes on HIGH.
4. Spoon onto a serving plate. Sprinkle with sesame seeds.

POTATOES PIZZAIOLA Serves 4-6

4 large potatoes
20 g butter
1 clove garlic, crushed
425 g can tomatoes, roughly chopped
2 teaspoons fresh (or 1/2 teaspoon dried) basil
ground black pepper and salt to taste
1/2 brown onion, finely diced
1 anchovy, minced

1. Peel and dice potatoes into 1.5 cm cubes, rinse and place in a large microwave safe glass bowl with 2 tablespoons of water, cover and cook for 8-10 minutes on HIGH, stirring halfway through cooking. Drain.
2. In a small microwave safe glass bowl, combine butter, garlic, onion and anchovy. Cook for 1/2-1 minute on HIGH, stir halfway.
3. Combine basil, pepper and salt to garlic mixture.
4. Add tomatoes and garlic mixture to potatoes, ensuring potatoes are well coated.
5. Cook, uncovered, for 5-7 minutes on HIGH, stirring halfway through cooking.

VEGETABLES

CAULIFLOWER AU GRATIN

Serves 4-6

500 g cauliflower florets
30 g butter
2 tablespoons flour
1 cup milk
1 teaspoon mustard
1/2 cup grated cheese
paprika

1. Place cauliflower in a flan dish. Cover and cook for 2-4 minutes on HIGH, until tender. Drain.
2. Melt butter in a microwave safe glass bowl for 30-40 seconds on HIGH.
3. Stir in flour. Cook for 1 minute on HIGH.
4. Gradually stir in milk and mustard. Cook for 2-2½ minutes on HIGH, stirring every minute.
5. Stir in cheese until melted.
6. Pour over cauliflower. Sprinkle with paprika.
7. Cook for 2-4 minutes on MEDIUM HIGH.

EASY HOME-MADE RISOTTO

Serves 6-8

1 onion, diced
60 g butter
4 rashers bacon, diced
(or 1 cup cooked chicken or ham)
3 chicken or beef stock cubes
2 cups boiling water
1 cup long-grain rice, washed well
1 cup assorted finely chopped vegetables,
e.g. carrots, zucchinis, mushrooms

1. Place onion, butter and bacon in a 3-litre casserole dish. Cook for 3-4 minutes on HIGH. Stir well.
2. Dissolve stock cubes in boiling water; add to onion and bacon. Add all other ingredients. Cover with a lid and cook for 23-25 minutes on HIGH. Do not stir while cooking.
3. At the end of this time, all the liquid will have been absorbed.
4. Leave to stand for 5 minutes and stir with a fork before serving.

SCALLOPED POTATOES

Serves 4-6

3 large potatoes (approx. 500 g), peeled and sliced thinly
1/2 large onion, sliced
1 cup grated tasty cheese
250 ml thickened cream
paprika
salt and pepper to taste

1. In a medium casserole dish, place 1/3 of the sliced potatoes to cover the dish.
2. Layer 1/2 of the sliced onion on top.
3. Sprinkle 1/3 of the grated cheese over the onion.
4. Repeat with second layer of potatoes, onion and cheese.
5. Finish with a layer of potatoes and pour over thickened cream.
6. Top with remaining cheese, salt and pepper to taste, sprinkle with paprika.
7. Cook uncovered for 10 minutes on MEDIUM HIGH.
8. Cook for a further 7-10 minutes on MEDIUM.
9. Stand for 5 minutes before serving.

HONEY CARROTS

Serves 4

500 g carrots, sliced lengthwise
60 g butter
1 tablespoon honey
1 teaspoon garlic, crushed
1 teaspoon sesame seeds

1. Combine all ingredients in a casserole dish.
2. Cover and cook for 5-6 minutes on HIGH. Stir halfway through cooking.
3. Stand covered for 3 minutes before serving.
4. Sprinkle with toasted sesame seeds.

VEGETABLE PLATTER

Serves 4

200 g carrots, sliced
200 g broccoli, cut into florets
100 g zucchini, sliced

1. Arrange vegetables in a shallow dish with the harder vegetables positioned around the outside and the softer vegetables in the centre.
2. Cover with a lid or plastic wrap.
3. Cook for 4-6 minutes on HIGH.
4. Stand covered for 3 minutes, before serving.

SEAFOOD

SEAFOOD LAKSA

Serves 4-6

1 tablespoon lemon grass, finely sliced
270 mL coconut cream
2 fish fillets or **300 g** king prawns or both
1 tablespoon oil
1-2 tablespoons Laksa paste

1 tablespoon fish sauce
1 packet of bean shoots
2 cloves garlic, crushed
1 packet of vermicelli noodles
1,125 mL Fish Stock

1. In a large microwave safe glass bowl cook Laksa paste, oil, lemon grass, and garlic for 1 minute on HIGH stirring once during cooking.
2. Add fish sauce, fish stock and cook for 3 minutes on HIGH.
3. Add cubed fish and or deveined prawns and cook for 7 minutes on MEDIUM. Stir through coconut cream and cook for a further 2-5 minutes.
4. Add noodles to a large microwave safe glass bowl of boiling water and let stand for 5-10 minutes, or until noodles collapse.
5. In a serving bowl place bean shoots, noodles and then Laksa soup.
6. Garnish with freshly torn coriander and fried onion flakes.

SMOKED SALMON TAGLIATELLE

Serves 4

500 g tagliatelle pasta
60 g butter
100 g smoked salmon
200 g snow peas, trimmed
100 g button mushrooms, finely sliced

2 cloves garlic, crushed
2 green onions, finely sliced
600 g thickened cream
1 tablespoon fresh dill
1 cup parmesan cheese

1. Place tagliatelle in a large microwave safe glass bowl with 6 cups of hot tap water. Cook for 10-12 minutes on HIGH, stirring halfway. Stand for 5 minutes then drain.
2. In a large microwave safe glass bowl cook garlic, butter and green onions for 1 minute on HIGH.
3. Add trimmed whole snow peas and button mushrooms, and cook for a further 2 minutes on HIGH.
4. In a large microwave safe glass bowl, place cream and cook for 5 minutes on MEDIUM, stirring once during cooking.
5. In a large shallow dish, combine pasta, snow peas, button mushrooms, smoked salmon and dill. Stir gently until the pasta is well coated.
6. Sprinkle with parmesan cheese and cook for 2 minutes on HIGH.

CRAB MORNAV

Serves 6

350 g fresh crabmeat or **2 x 170 g** cans crab meat, drained
5 cloves garlic, crushed
60 g butter
1/3 cup plain flour
1/2 teaspoon dry mustard
2 cups milk

1 onion, finely chopped
1/2 cup grated cheese
4 tablespoons tomato sauce
1/2 teaspoon tabasco
2 teaspoons Worcestershire sauce
3 tablespoons cream

1. In a large microwave safe glass bowl, melt butter for 1 minute on HIGH. Stir in flour and mustard. Cook for a further 1 minute on HIGH.
2. Gradually stir in milk. Cook for 3-5 minutes on HIGH, stirring every minute.
3. Stir in onion, crab meat, salt and pepper, $\frac{1}{4}$ cup cheese, tomato sauce, tabasco, Worcestershire sauce, cream and garlic.
4. Place into a 1-litre serving dish. Sprinkle with remaining cheese.
5. Cook for 8-10 minutes on MEDIUM.
6. Serve in volavaunt shells with a garden salad.

CHEESY SALMON CANNELLONI

Serves 4-6

1 large packet cannelloni
250 g ricotta cheese
90 g cheddar cheese
salt and pepper to taste
2 eggs lightly beaten
210 g can red salmon, drained with bones removed
2 teaspoons lemon juice
2 tablespoons fresh parsley, chopped
2 tablespoons of extra cheddar cheese
375 g jar pasta sauce

1. Combine ricotta cheese, cheddar cheese, salt and pepper, eggs, salmon and lemon juice and mix well.
2. Place spoonfuls of salmon mixture into cannelloni shells until full.
3. Place in a single layer in a shallow dish.
4. Pour pasta sauce over cannelloni and smooth over with the back of a spoon to ensure all sections of pasta are covered with sauce.
5. Cook for 14 minutes on MEDIUM HIGH.
6. Remove dish and sprinkle with extra cheese. Continue cooking on MEDIUM HIGH for a further 2-4 minutes. Allow to stand for 10 minutes before serving.
7. Sprinkle with chopped parsley to serve.

GARLIC MUSSELS

Serves 4 as entree

250 g mussels
250 g New Zealand mussels
1 cup wine
2 cups water
1 clove garlic, crushed

GARLIC BUTTER
40 g butter
2 tablespoons olive oil
2 cloves garlic, crushed
pepper

1. Wash mussels under running water; remove all traces of mud, seaweed and barnacles with brush or knife; remove beards. Discard cracked, broken or open mussel shells.
2. In a large microwave safe glass bowl, cover mussels with wine, water and garlic. Cook for 14-16 minutes on MEDIUM or until opened, removing from liquid as they open. Discard unopened mussels.

GARLIC BUTTER

1. Melt butter in jug for 30 seconds on HIGH, add oil, garlic and pepper. Pour $\frac{1}{2}$ garlic sauce over mussels; toss well.
2. Arrange mussels in serving bowl and pour remaining sauce over mussels.

SEASONED CHICKEN PARCELS

Serves 4

3 shallots, chopped finely
1/2 cup fresh (white) bread crumbs
1 clove garlic, crushed
1 egg yolk
1/2 cup pine nuts, chopped finely
100 g bacon

3/4 cup vintage cheddar, grated
2 tablespoons finely chopped fresh basil
4 large single chicken breasts
20 g melted butter
salt and pepper to taste

1. Mallet chicken breasts until flat.
2. Mix all other ingredients in a small bowl.
3. Season each chicken breast and place mixture in the centre.
4. Roll and tie chicken with string so as no filling is exposed.
5. Place in casserole dish and brush with butter.
6. Cook for 8-12 minutes on MEDIUM HIGH. Turn over halfway during cooking.
7. Stand for 5 minutes, covered in foil.

TANDOORI CHICKEN

Serves 4-6

2 fresh red chillies, seeded
1 onion
2 cloves garlic, crushed
2 teaspoons crushed ginger
2 tablespoons lemon juice
2 teaspoons ground cumin
1/2 teaspoon black pepper
3 teaspoons ground coriander
2 whole cloves

1/4 teaspoon cinnamon
1 bay leaf
1/2 teaspoon turmeric
1/2 teaspoon nutmeg
2 teaspoons paprika
6 chicken thighs, skin removed
200 g low-fat yoghurt

1. In a Food Processor, pureé chillies, onion, garlic, ginger and lemon juice until smooth.
2. Mix cumin, pepper, coriander, cloves, cinnamon, bay leaf, turmeric, nutmeg and paprika in a small bowl.
3. Cook for 1 minute on HIGH, stirring halfway through cooking. Remove bay leaf and cloves.
4. Combine chilli mixture, spices and yoghurt together. Spread over chicken.
5. Cover and marinate overnight, stirring occasionally.
6. Place on a roasting rack, cook for 19-21 minutes on MEDIUM HIGH. Turn over halfway through cooking.
7. Serve with boiled rice.

HONEY CHICKEN LEGS

Serves 4

250 mL soy sauce
4 tablespoons honey
1 tablespoon lemon juice
1 clove garlic, crushed

1/2 teaspoon freshly grated ginger
2 tablespoons oil
8 large chicken legs
sesame seeds

1. Combine soy sauce, honey, lemon juice, garlic, ginger and oil in a small bowl. Pour over chicken and marinate for 2-3 hours.
2. Sprinkle with sesame seeds.
3. Arrange chicken legs on a roasting rack. Cook for 22-26 minutes on MEDIUM HIGH, turning over halfway through cooking.
4. Allow to stand for 5 minutes.

CRUNCHY CAMEMBERT CHICKEN

Serves 6

125 g camembert cheese, finely chopped
2 rashers bacon, finely chopped
1/2 cup toasted, slivered almonds

2 tablespoons seeded mustard
Approx. 1.5 kg chicken
2 tablespoons honey

1. Mix camembert, bacon, almonds and 1 tablespoon mustard together.
2. Press camembert mixture between skin and flesh of chicken. Tie chicken legs together.
3. Mix remaining mustard and honey. Brush over chicken.
4. Place breast side down on a roasting rack, cook for 30-32 minutes on MEDIUM HIGH. Turn over halfway through cooking.
5. Allow to stand covered with foil for 10 minutes before serving.

POULTRY

CHICKEN IN A POT

Serves 4-6

1.5 kg chicken thighs
1/4 cup plain flour
2 rashers bacon, finely chopped
1 green capsicum, diced
1 onion, finely chopped
425 g can peeled tomatoes

2 tablespoons tomato paste
2 chicken stock cubes
1 tablespoon soy sauce
salt and pepper
200 g mushrooms, sliced

1. Toss chicken thighs in flour.
2. Combine all ingredients, except mushrooms, in a 3-litre casserole dish.
3. Cover and cook for 30-35 minutes on MEDIUM HIGH. Stir 2-3 times during cooking.
4. Add mushrooms. Cook, uncovered, a further 5-7 minutes on MEDIUM HIGH.

CHICKEN FILLET BURGERS

Serves 4

2 chicken breast fillets
1 pkt of chicken coating mix
30 g melted butter

TOPPING 1 HAWAIIAN

1 slice ham, sliced in half
2 slices pineapple, sliced in half
3 slices cheddar cheese

TOPPING 2 MEDITERRANEAN

4 pieces of prosciutto
4 pieces of marinated vegetables such as eggplant or roast capsicum
1/4 cup grated vintage cheese
1/4 cup Parmesan cheese

1. Brush fillets with butter.
2. Place chicken and seasoning mix into a freezer bag. Toss to coat chicken.
3. Place chicken fillets onto a roasting rack.
4. Cook for 6-8 minutes on MEDIUM HIGH, turning halfway through cooking.
5. Layer topping on chicken, finishing with cheese.
6. Cook for 4-6 minutes on MEDIUM.
7. Serve on a roll with salad.

CHICKEN WITH BACON AND LEEK SEASONING

Serves 4

Approximately 1.5 kg chicken
60 g butter, melted
1 leek, finely chopped
1 rasher bacon, chopped

3/4 cup wholemeal breadcrumbs
1 egg yolk
salt and pepper
20 g butter, melted, extra

1. Combine butter, leek and bacon in a microwave safe glass bowl. Cook for 1-2 minutes on HIGH.
2. Stir in breadcrumbs, egg yolk and seasonings. Mix well.
3. Fill cavity of chicken with stuffing and secure with a toothpick.
4. Brush chicken with extra melted butter.
5. Place chicken on a rack, breast-side down, cook for 11-13 minutes on MEDIUM HIGH.
6. Turn over, cook a further 11-13 minutes on MEDIUM HIGH.
7. Stand covered with foil for 10 minutes before carving.

CHICKEN PENNE SALAD

Serves 6

Approximately 1.5 kg chicken
20 g butter
1 packet picador cheese (soft capsicum - flavoured cheese)
1 cup chicken stock
1/2 red capsicum, chopped
1/2 yellow capsicum, chopped
1 stick celery, chopped
2 cups penne pasta
4 cups hot tap water
1 tablespoon fresh chives

1. Brush chicken with butter melted for 20 seconds on HIGH.
2. Cook chicken for 28-32 minutes on MEDIUM HIGH turning over halfway through cooking.
3. Cool and then remove chicken flesh from the bone.
4. Cook pasta in a large microwave safe glass bowl for 15-16 minutes on HIGH. Stand for 5 minutes, stir and strain. Set aside to cool.
5. Melt cheese by combining with chicken stock in a microwave safe glass bowl and cooking on HIGH for 2 minutes.
6. Combine all other ingredients and mix well with chicken, pasta and sauce.

VEAL AND EGGPLANT

Serves 4-6

750 g veal, diced
1 large eggplant, cubed
1 tablespoon flour
2 teaspoons fresh sage
black pepper to taste
1 teaspoon chicken stock powder
4 rashers bacon, chopped

3 shallots, sliced
1 yellow capsicum, sliced
420 g can peeled tomatoes
2 tablespoons continental parsley, chopped
2 tablespoons tomato paste

1. Place flour, sage, stock powder, pepper and veal into a freezer bag, toss well to coat the veal.
2. Transfer the meat and any flour remaining in the bag to a 3-litre casserole dish.
3. Add the bacon, green onions, tomatoes, capsicum, tomato paste and eggplant. Mix well. Cover and cook for 32-34 minutes on MEDIUM, stirring 2-3 times during cooking.
4. Sprinkle with parsley and serve with rice and Kalamata olives.

ITALIAN SPAGHETTI SAUCE

Serves 4-6

500 g topside mince
1 onion, chopped
2 cloves garlic, crushed
410 g can whole tomatoes
1/2 cup tomato paste

100 g mushrooms, sliced
1 tablespoon chopped fresh parsley
1 tablespoon fresh oregano leaves
1 tablespoon fresh basil leaves

1. Mix mince, onion and garlic together in a large microwave safe glass bowl. Cook for 8-10 minutes on MEDIUM HIGH, stirring every 2 minutes. Drain well.
2. Stir in canned tomatoes, tomato paste, mushrooms, parsley, salt, oregano and basil.
3. Cook for a further 6-8 minutes on MEDIUM HIGH. Stir halfway through cooking.
4. Serve over hot spaghetti.

INDIAN CURRY LAMB

Serves 4-6

1 small sweet potato, cubed
1 onion, thinly sliced
1 kg lamb, trimmed and cubed
1 cup chicken stock
1 teaspoon chicken stock powder, extra

1 tablespoon curry paste
300 g can of chickpeas
3 zucchini, cubed
2 tablespoons fresh coriander or parsley, chopped

1. Place onion and curry paste in a small microwave safe glass bowl, cook for 1 minute on MEDIUM HIGH.
2. Place onion, lamb, sweet potato, chicken stock and stock powder into a 3-litre casserole dish.
3. Cover and cook for 28-30 minutes on MEDIUM, stirring twice during cooking.
4. Add zucchini and cook for a further 1-2 minutes on HIGH.
5. Combine lamb, canned chickpeas and stock mixture in a 3-litre casserole dish and cover.
6. Heat through for 6-8 minutes on MEDIUM.
7. Stir through coriander, and serve.

CHILLI CON CARNE

Serves 4-6

1 kg mince
1 large onion, finely chopped
825 g can peeled tomatoes
salt and pepper
1-2 teaspoons chilli powder

1 tablespoon vinegar
1 teaspoon sugar
375 g jar tomato paste
425 g can red kidney beans, drained

1. Mix mince and onion together in a large microwave safe glass bowl. Cook for 10-12 minutes on MEDIUM HIGH, stirring every 2 minutes. Drain excess liquid.
2. Stir in tomatoes, salt and pepper, chilli powder, vinegar, sugar, tomato paste and kidney beans.
3. Cook for 18-20 minutes on MEDIUM HIGH, stirring twice during cooking.
4. Serve with boiled rice.

HONEY ROAST LAMB

Serves 4-6

1.5 kg leg of lamb
3 tablespoons honey
1 tablespoon Dijon mustard

1. Combine honey and Dijon mustard. Brush over lamb.
2. Place fat-side down on a roasting rack.
3. Cook for 26-28 minutes on MEDIUM HIGH (for medium) or 32-34 minutes on MEDIUM HIGH (for well done).
4. Turn over halfway through cooking shielding shank with foil to prevent overcooking. Brush combined ingredients over leg of lamb. Allow to stand for 10 minutes covered with foil before carving.

MEAT

LASAGNE

Serves 8

MEAT SAUCE INGREDIENTS

30 g butter
1 onion, chopped
1 kg topside mince
1/4 cup tomato paste
300 g jar Napolitana sauce
1 cup fresh button mushrooms, sliced
2 cloves garlic, crushed (optional)
1 tablespoon fresh oregano
Salt and pepper to taste

CHEESE SAUCE INGREDIENTS

90 g butter
1/3 cup flour
1 3/4 cups milk
125 g tasty cheese, grated
200 g packet instant lasagne sheets
100 g mozzarella cheese, grated

MEAT SAUCE METHOD

1. Place butter and onion in a large microwave safe glass bowl. Cook for 2-3 minutes on HIGH.
2. Stir in mince. Cook, uncovered, for 12-14 minutes on MEDIUM HIGH, stirring every 2 minutes. Drain excess fat.
3. Stir in tomato paste, Naopolitana sauce, mushrooms, garlic, oregano and salt and pepper.

CHEESE SAUCE METHOD

1. Melt butter in a medium sized microwave safe glass bowl for 40-50 seconds on HIGH. Stir in flour; cook for further 40-50 seconds on HIGH.
2. Gradually stir in milk. Cook for 4-6 minutes on HIGH, stirring every minute.
3. Stir in tasty cheese.

TO ASSEMBLE

1. Use a 3-litre deep casserole dish.
2. Stand lasagne sheets in hot water for 5 minutes.
3. Spoon meat sauce to just cover base of dish. Cover with a single layer of Lasagne sheets.
4. Spoon over sheets one-third of meat sauce. Cover with one-third of cheese sauce.
5. Repeat the process 3 times, ending with the cheese sauce.
6. Sprinkle with mozzarella cheese.
7. Cook for 10 minutes on MEDIUM HIGH with the lid on. Remove lid and continue cooking for a further 10 minutes on MEDIUM HIGH.
8. Allow to stand 10 minutes before serving.
9. Serve with a fresh garden salad and bread.

GOLDEN CURRY SAUSAGES

Serves 4-6

1 kg sausages
1 onion, finely sliced
40 g butter
3 teaspoons curry powder
1 1/2 cups water

2 tablespoons plain flour
1 carrot, grated
2 tablespoons Worcestershire sauce
1 tablespoon brown sugar
2 tablespoons brown vinegar

1. Pierce sausages with a fork twice. Arrange on a microwave safe rack.
2. Cook sausages for 14-16 minutes on MEDIUM, turning halfway through cooking. After cooled, slice into rounds.
3. Mix sugar, vinegar, curry powder, flour, Worcestershire sauce and water together in a jug.
4. In a 3-litre casserole dish combine butter, onions and cook for 2-3 minutes on HIGH, or until onions become transparent.
5. Add carrot, sausages and sauce. Mix well and cook for an extra 6-7 minutes on MEDIUM.
6. Serve hot with Basmati rice and pappadums.

SHEPHERD'S PIE

Serves 6-8

4 large potatoes (approx.1 kg)
butter
milk
2 tablespoons fresh chives, chopped
salt and pepper
1 kg minced beef
1 onion, chopped

2 tablespoons gravy powder
250 g frozen mixed vegetables
1 tablespoon Worcestershire sauce
1 can chopped tomatoes
2 tablespoons parsley
60 g grated cheddar cheese
salt and pepper to taste

1. Peel and cut potatoes into 2.5 cm cubes. Place in a large microwave safe glass bowl. Add 2 tablespoons water; cover and cook for 10-16 minutes on HIGH or until tender. Stir halfway through cooking. Drain.
2. Mash potatoes; add butter, milk, chives, salt and pepper until it forms a smooth consistency.
3. In a large microwave safe glass bowl, combine mince and onion and cook for 8 minutes on MEDIUM HIGH, stirring every 2 minutes. Drain juices from meat.
4. Place frozen mixed vegetables in a shallow dish and cook for 2 minutes on HIGH.
5. Add gravy powder, mixed vegetables, Worcestershire sauce, tomatoes, parsley and seasoning. Mix well.
6. Spoon mixture into a 25 x 20 cm rectangular dish.
7. Spread mashed potato evenly over top of mixture. Sprinkle cheese on top.
8. Cook for 20-22 minutes on MEDIUM HIGH.
9. Allow to stand covered with foil for 10 minutes before serving.

QUICK AND EASY RECIPES

3. *Asian Greens*

500 g Asian greens (including gai larn, bok choy)
oyster sauce

1. Wash and trim the greens. Cut into equal lengths of approximately 10 cm. Place in a large microwave safe glass bowl and cover with plastic wrap. Cook on Quick and Easy No.3- "Asian greens".
2. After cooking, stand covered 1 minute. Stir and serve with oyster sauce.
3. Serve as a side dish with an Asian meal or alone with rice.

Serves 2-4

4. *Garlic Prawns*

60 g butter
3 cloves garlic, crushed
24 green king prawns, peeled, tails intact, deveined (Approximately 500 g)
1 tablespoon chopped fresh parsley

1. Combine the butter and garlic in a large microwave-safe bowl. Cook on Quick and Easy No.4- "Garlic prawns".
2. When the oven has stopped and ADD PRAWNS is displayed, stir in the prawns and continue cooking.
3. When the oven has stopped and STIR is displayed, stir and continue cooking.
4. Serve in individual dishes sprinkled with parsley.

Serves 4

5. *Nachos*

250 g salsa
1 cup red kidney beans
200 g corn chips
1 cup grated cheese
sour cream

1. In a medium bowl mix salsa and red kidney beans together.
2. Place corn chips in a large flan dish.
3. Pour over topping and sprinkle with grated cheese. Cook on Quick and Easy No.5- "Nachos".
4. After cooking, stand 2 minutes.
5. Serve topped with sour cream.

6. *Pecan Fudge*

125 g butter
2 tablespoons golden syrup
1 x 395 g can sweetened condensed milk
1 cup brown sugar (optional)
100 g packet choc bits
1 cup (125 g) roughly chopped pecans
1/2 teaspoon vanilla essence

1. Place the butter, golden syrup, condensed milk and sugar into a microwave-safe bowl. Mix well. Cook on Quick and Easy No.6- "Pecan fudge".
2. When the oven has stopped and STIR is displayed, stir and continue cooking. To avoid a grainy texture, do not scrape the undissolved sugar crystals from the sides down into the bowl during cooking.
3. After cooking, Stir in the choc bits, pecans and vanilla essence.
4. Pour the mixture into a greased and lined 28 x 18 cm lamington tin.
5. Refrigerate until firm. Cut into squares.

Makes 36 pieces

NOTE: Sugar only alters the sweetness of the fudge.

QUICK AND EASY RECIPES

1. San Choy Bau

- 1 tablespoon sesame oil
- 2 cloves garlic, grated
- 5 cm fresh ginger, finely chopped
- 500 g pork or chicken mince
- 100 g button mushrooms, finely diced
- 4 tablespoons oyster sauce
- 1 tablespoon finely chopped red capsicum
- 1 tablespoon finely chopped green capsicum
- 1 x 240 g can water chestnuts, drained and finely diced
- 3 teaspoons fish sauce
- 50 g bean sprouts
- 2 green onions, sliced
- 1 teaspoon chopped fresh coriander (cilantro)
- 12 evenly sized iceberg lettuce leaves, washed

1. Place the oil, garlic and ginger into a large microwave-safe bowl. Cook on Quick and Easy No.1- "San choy bau"
2. When the oven has stopped and ADD MINCE is displayed, add the mince and separate with a fork and continue cooking.
3. When the oven has stopped and STIR is displayed, stir mince and continue cooking.
4. When the oven has stopped and ADD REMAINING INGREDIENTS is displayed, add the remaining ingredients, except the lettuce, and combine well, and continue cooking.
5. Place a few spoonfuls of the cooked mixture in the centre of each lettuce leaf and roll up to eat.

Serves 4-6

2. Chicken Caesar Salad

- 1 tablespoon Worcestershire sauce
- 1 teaspoon Dijon mustard
- 300 g chicken breasts, cut into thin strips
- 2 rashers bacon
- 1 Cos lettuce, washed and torn
- 1/2 cup grated parmesan cheese

Dressing

- 1/2 cup natural yogurt
- 1/4 cup whole egg mayonnaise
- 1 tablespoon Dijon mustard
- 2 cloves fresh garlic, crushed
- 2 anchovy fillets, minced



1. To make the dressing, combine all of the ingredients in a bowl and mix well. Allow to stand for at least 30 minutes in the refrigerator to allow the flavours to develop.
2. In a small bowl, combine the Worcestershire sauce and mustard. Stir through the chicken.
3. Place the chicken in a single layer on a microwave-safe rack. Cook on Quick and Easy No.2- "Chicken caesar salad".
4. When the oven has stopped and TURN OVER is displayed, turn the chicken over and continue cooking.
5. When the oven has stopped and REMOVE CHICKEN, ADD BACON is displayed, remove the chicken. Place the bacon between pieces of paper towel and continue cooking. Allow bacon to cool before slicing into thin strips. Set aside.
6. In a large salad bowl, combine the chicken, lettuce, bacon and parmesan cheese. Toss through the dressing to coat.
7. Serve with croutons and whole anchovy fillets if desired.

Serves 4

EASY DEFROST MENU GUIDE

EASY
DEFROST

When you defrost the following menus with EASY DEFROST, press the EASY DEFROST pad until the desired menu appears in the display.

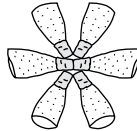
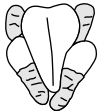
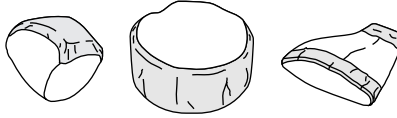
No.	Menu	Quantity min-max (kg's)	Procedure	Standing Time (minutes)
1	Minced Meat Beef 	0.1-3.0	<ul style="list-style-type: none"> Place frozen minced meat on a defrost rack. Shield edges. When the oven has stopped, remove defrosted portions of mince, turn over and shield edges with foil strips. After defrost time, stand covered with aluminium foil. See NOTE below. 	5-30
2	Steak/Chops Fish Fillets 	0.1-3.0 0.1-1.0	<ul style="list-style-type: none"> Shield thin end of chops or steaks with foil. Position the food with thinner parts in the centre in a single layer on a defrost rack. If pieces are stuck together, try to separate as soon as possible. When the oven has stopped, remove defrosted pieces, turn over and shield the warm portions of remaining pieces. After defrost time, stand covered with aluminium foil. See NOTE below. 	5-30 (Steak/ Chops) 5-15 (Fish fillets)
3	Chicken Pieces 	0.1-3.0	<ul style="list-style-type: none"> Shield the exposed bone with foil. Place chicken pieces on a defrost rack. When the oven has stopped, remove any defrosted pieces, turn over and shield the warm portions of remaining pieces. After defrost time, stand covered with aluminium foil. See NOTE below. 	5-15
4	Poultry 	1.0-4.0	<ul style="list-style-type: none"> Remove from original wrapper. Shield wing and leg tips with foil. Place breast side down on a defrost rack. When the oven has stopped, turn over and shield the warm portions. After defrost time, stand covered with aluminium foil. <p>N.B. After standing run under cold water to remove giblets if necessary.</p>	5-50
5	Roast Meat Beef/Pork Lamb 	0.5-3.0 0.5-2.5	<ul style="list-style-type: none"> Shield the bone and the edge with foil strips about 2.5cm wide. Place joint with lean side face upwards (if possible) on a defrost rack. When the oven has stopped, turn over and shield the warm portions. After defrost time, stand covered with aluminium foil. 	5-60
6	Bread	1-6 slices	<ul style="list-style-type: none"> Separate slices and place between paper towel on turntable. After defrosting, stand. 	1

Foods not listed in the Guide can be defrosted manually using M•LOW setting.

NOTE: When freezing minced meat, shape it into flat even sizes.

For chicken pieces, steaks and chops, freeze separately in single flat layers and if necessary separate into layers with freezer plastic.

This will ensure even defrosting.

It is also a good idea to label the packs with the correct weights.

VEGETARIAN MEAL RECIPES

3. Spring Vegetable Rice Bake

- 1 cup parboiled rice
- 3 large tomatoes, 2 thinly sliced, 1 diced
- 2 potatoes, peeled and thinly sliced
- 2 small yellow capsicums, 1 cut into strips, 1 diced
- 1 zucchini, diced
- 2 small carrots, diced
- 1 Spanish onion, diced
- 2 tablespoons fresh continental parsley, finely chopped
- pinch of paprika
- salt and pepper to taste
- 1 teaspoon vegeta (vegetable stock)
- 1 teaspoon extra virgin olive oil.

1. Cook the rice on Rice/Pasta No. 1- "White Rice " (1 cup), referring to the menu guide for White Rice.
2. Place the diced tomato, diced capsicum, onion, zucchini, carrots, parsley, rice, seasoning, vegeta and olive oil in a large bowl. Mix until well combined.
3. Place the mixture in a shallow dish. Layer the sliced potatoes, followed by the sliced tomato and cut capsicum. Sprinkle with the paprika. Cover with lid or plastic wrap. Cook on Vegetarian Meal No. 3- "Spring Vegetable Rice Bake".
4. After cooking, stand covered for 5 minutes.

Serves 6

Nutrition per serve

1.2g Fat; 0.3g Saturated fat; 5.8g Protein; 34.8g Carbohydrate; 5.8g Dietary fibre; 780kJ

4. Herbed Jacket Potatoes

- 4 new potatoes, approx. 200g
- 40 g baby spinach leaves, finely chopped
- 2 tablespoons mixed fresh herbs, finely chopped (oregano, basil, parsley, tarragon)
- 2 green onions, sliced
- 5 sundried tomatoes (not in oil), finely chopped
- 50 g mushrooms, finely chopped
- 250 g low fat cottage cheese
- seasoning to taste

1. Cook the potatoes on Vegetables No. 4- "Jacket Potato", referring to the menu guide for Jacket Potato.
2. Combine all ingredients except potatoes in a medium sized bowl.
3. Hollow out the centre of each potato using a small spoon. Add the potato flesh to the mixture. Mix well.
4. Fill each potato with the mixture. Place on a microwave safe dinner plate. Cook on Vegetarian Meal No. 4- "Herbed Jacket Potatoes".
5. After cooking, stand uncovered for 2 minutes.

Serves 4

Nutrition per serve

0.9g Fat; 0.5g Saturated fat; 7.7g Protein; 20.1g Carbohydrate; 3.8g Dietary fibre; 537.6kJ

5. Vegetable Couscous

- 1 Spanish onion, finely sliced
- 1 clove garlic, crushed.
- 1/2 eggplant, cut into 1cm cubes
- 2 zucchinis, cut into 1cm cubes
- 1 red capsicum, cut into chunks
- 1 yellow capsicum, cut into chunks
- 150 g button mushrooms, cut in quarters
- 2 large tomatoes, cut into 2cm cubes
- 1/4 cup dry white wine
- 1 teaspoon extra virgin olive oil
- 1 1/4 cups couscous
- seasoning to taste
- juice of half a lemon

1. Place the onion, oil and wine in a small microwave safe glass bowl. Cook on Vegetarian Meal No. 5- "Vegetable Couscous".
2. When the oven stops and ADD VEGETABLES is displayed, place all the vegetables including the onion in a 3 litre casserole dish. Cover with lid or plastic wrap and continue cooking.
3. When the oven stops and STIR is displayed, stir and continue cooking.
4. After cooking, add the couscous. Season to taste. Add the lemon juice. Mix until well combined. Stand covered for 5 minutes.

Serves 6

Nutrition per serve

1.8g Fat; 0.5g Saturated fat; 8.7g Protein; 33.6g Carbohydrate; 5.5g Dietary Fibre; 780kJ

VEGETARIAN MEAL RECIPES

1. Spinach and Ricotta Cannelloni

- 1 250g packet frozen spinach
- 375 g reduced fat ricotta cheese
- 12 instant cannelloni tubes
- pinch of ground nutmeg
- salt and pepper to taste
- 500 g jar Summer Tomato Basil Pasta Sauce

1. Place the frozen spinach in a bowl. Cover with plastic wrap. Cook on Vegetarian Meal No. 1- "Spinach and Ricotta Cannelloni".
2. When the oven stops and STIR is displayed, stir and continue cooking.
3. When the oven stops and STRAIN SPINACH ADD TO CHEESE is displayed, strain the water from the spinach, pat dry with paper towel.
4. Place the ricotta cheese, spinach, nutmeg and seasoning in a bowl. Mix until well combined.
5. Place the mixture into a piping bag. Fill the cannelloni tubes by gently squeezing the piping bag until the tube is filled. Place the tubes in a single layer in a shallow casserole dish.
6. Pour the pasta sauce over the tubes. Smooth over with the back of a spoon to ensure all sections of the tubes are covered with the sauce. Cover with lid or plastic wrap and continue cooking.
7. After cooking, stand covered for 2 minutes.
8. Serve with a green salad and a little freshly grated Parmesan cheese.

Serves 4

Nutrition per serve

10.6g Fat; 6.5g Saturated fat; 15.3g Protein; 27.4g Carbohydrate; 9.8g Dietary fibre; 1198kJ

2. Vegetables with Hokkien Noodles

- 200 g snow peas, topped, tailed and sliced in half
- 1 bunch broccolini, cut into 5cm lengths
- 1 125g packet baby corn, cut in half
- 2 bunches baby bok choy, cut in half
- 100 g oyster mushrooms, cut in half
- 1 carrot, thinly sliced
- 1 zucchini, thinly sliced
- 1/2 red capsicum, cut into strips
- 1/2 yellow capsicum, cut into strips
- 2 green onions, finely sliced
- 1 clove garlic, crushed
- 2 cm piece ginger, grated
- 50 g bean shoots
- 1 teaspoon sesame oil
- 2 tablespoons oyster sauce
- 2 tablespoons sweet chilli sauce
- 1 tablespoon light soy sauce
- 1 packet hokkien noodles

1. Add the sesame oil, garlic, and ginger to a large microwave safe glass bowl. Cook on Vegetarian Meal No. 2- "Vegetables with Hokkien Noodles".
2. When the oven stops and ADD CARROTS CAPSICUM BABYCORN GREEN ONIONS AND MUSHROOMS is displayed, add the carrot, baby corn, capsicums, green onions and oyster mushrooms. Cover with lid or plastic wrap and continue cooking.
3. When the oven stops and ADD GREEN VEGETABLES is displayed, add the snow peas, broccolini, baby bok choy and zucchini and continue cooking.
4. When the oven stops and STIR is displayed, stir and continue cooking.
5. After cooking, stand covered for 2 minutes.
6. Place the hokkien noodles in a large bowl, cover with boiling water. Stand for 2 minutes. Separate with a fork. Strain.
7. Add the noodles to the vegetables. Add the sauces and bean shoots. Combine well.

Serves 6

Nutrition per serve

1.3g Fat; 0.3g Saturated fat; 9.7g Protein; 39g Carbohydrate; 7.0g Dietary fibre; 933kJ

LOW FAT MEAL RECIPES

3. Sesame Prawns

- 36 green prawns, peeled and deveined, leaving tails intact (Approximately 650 g)
- 1 clove garlic, crushed
- 1 tablespoon ketjap manis*
- 2 teaspoons sesame oil
- 1 tablespoon sesame seeds
- 100 g snow peas, topped, tailed and cut in half
- 1 red capsicum, cut into thin strips

1. Combine the prawns, oil, garlic and ketjap manis in a large macrowave-safe glass bowl. Stir well. Cover and refrigerate for at least 2 hours or overnight.
2. Add the sesame seeds and capsicum. Cook on Low Fat Meal No. 3- "Sesame Prawns".
3. When the oven stops and STIR is displayed, stir and continue cooking.
4. When the oven stops and ADD SNOWPEAS is displayed, add the snow peas and continue cooking.
5. When the oven stops and STIR is displayed, stir and continue cooking.
6. After cooking, stand for 2 minutes.
7. Serve with basmati rice.

* Ketjap Manis is a thick Indonesian soy sauce available from the Asian section at supermarkets.

Serves 4

Nutrition per serve

1.9g Fat; 0.6g Saturated fat; 26.6g Protein; 2.7g Carbohydrate; 1.0g Dietary Fibre; 579kJ

4. Garlic and Chilli Baby Octopus Salad

- 1 kg baby octopus, cleaned
- 2 cloves garlic, crushed
- 2 birds- eye chillies, finely chopped
- juice of one lemon
- 1 tablespoon ketjap manis

Salad Ingredients

- 1 bunch red oak lettuce, rinsed
- 1 punnet cherry tomatoes, cut in half
- 1/2 Spanish onion, finely sliced
- 1 yellow capsicum, finely sliced
- 1 Lebanese cucumber, finely sliced
- juice of one lemon
- seasoning to taste

1. Rinse the baby octopus thoroughly, making sure the heads are clean.
2. Place the octopus in a large microwave safe glass bowl with the garlic, chillies and ketjap manis. Cover and refrigerate for 30 minutes.
3. Remove the cover. Add the lemon juice. Cook on Low Fat Meal No. 4- "Garlic and Chilli Baby Octopus Salad".
4. When the oven stops and STIR is displayed, stir and continue cooking.
5. Place the lettuce, onion, tomatoes, capsicum and cucumber in a serving dish.
6. After cooking, stand the octopus for 2 minutes.
7. Add the octopus to the salad. Dress with the lemon juice and seasoning.

Serves 6

Nutrition per serve

1.3g Fat; 0.6g Saturated fat; 14.8g Protein; 2.7g Carbohydrate; 2.9g Dietary fibre; 372kJ

5. Lemon Fish Fillets

- 4 x 150 g fish fillets
- 1 tablespoon lemon juice
- salt and pepper to taste
- 1 tablespoon fresh flat leaf parsley, finely chopped

1. Place the fish in a single layer into a shallow casserole dish.
2. Pour the lemon juice. Season with salt and pepper.
3. Cover with lid or plastic wrap. Cook on Low Fat Meal No. 5- "Lemon Fish Fillets".
4. When the oven stops and TURN OVER is displayed, turn the fish over and continue cooking.
5. After cooking, stand covered for 2 minutes.
6. Sprinkle with the parsley and serve with a green salad.

Serves 4

Nutrition per serve

9.5g Fat; 2.5g Saturated fat; 25.5g Protein; 0.9g Carbohydrate; 2.5g Dietary fibre; 820kJ

HEALTHY MENUS MENU GUIDE

The final cooking result will vary according to the food condition (e.g. initial temperature, shape, quality). Check the food after cooking and if necessary continue cooking manually.

LOW FAT MEAL RECIPES

1. Mediterranean Chicken

- 1 clove garlic, crushed
- 1 tablespoon fresh basil, chopped
- 1 tablespoon fresh oregano, chopped
- juice of half a lemon
- 6 olives, finely sliced
- 5 sundried tomatoes (not in oil), finely chopped
- 20 g baby spinach leaves
- 1 Spanish onion, finely sliced
- 1/4 cup white wine
- 500 g jar Summer Tomato Basil Pasta Sauce
- 2 chicken breasts, trimmed of fat and sliced in half lengthwise
- 4 fresh chives

1. Place each chicken breast between baking paper. Flatten to 1/2 cm thick using a rolling pin.
2. Combine the garlic, basil, oregano and lemon juice in a small bowl.
3. Smear each chicken breast with the herb mixture. Layer with the baby spinach leaves.
4. Place olives and sundried tomatoes in the centre of each chicken breast equally. Roll up the chicken breasts, securing with the fresh chives. Place the chicken rolls in a shallow casserole dish.
5. Place the onion and wine in a small microwave safe glass bowl. Cook on Low Fat Meal No. 1- "Mediterranean Chicken".
6. When the oven stops and ADD ONIONS TO CHICKEN is displayed, add the onion and sauce to the chicken. Cover with lid or plastic wrap and continue cooking.
7. When the oven stops and REARRANGE is displayed, rearrange and continue cooking.
8. After cooking, stand covered for 5 minutes.

Serves 4

Nutrition per serve

2.5g Fat; 0.5g Saturated fat; 27.5g Protein; 9.4g Carbohydrate; 4.7g Dietary fibre; 758kJ

2. Chinese Beef

- 650 g blade steak, trimmed of fat and thinly sliced
- 2 cloves garlic, crushed
- 2 cm piece ginger, grated
- 1 teaspoon sesame oil
- 1/2 cup beef stock
- 1/2 teaspoon cornflour
- 2/3 cup oyster sauce
- 1 large onion, sliced
- 2 carrots, thinly sliced
- 125 g baby corn, cut in half
- 1 red capsicum, cut into strips
- 170 g snow peas, topped, tailed and sliced in half



1. Combine the beef, garlic, ginger and sesame oil in a 3 litre casserole dish. Cover with lid or plastic wrap. Cook on Low Fat Meal No. 2- "Chinese Beef".
2. When the oven stops and STIR is displayed, stir and continue cooking.
3. When the oven stops and DRAIN JUICES ADD SAUCES ONION AND CARROT is displayed, drain the juices. Combine the stock, oyster sauce and cornflour in a jug, stir well, and pour over the beef. Add the onion and carrots and continue cooking.
4. When the oven stops and ADD CAPSICUM AND BABYCORN is displayed, add the baby corn and capsicum and continue cooking.
5. When the oven stops and ADD SNOWPEAS is displayed, add the snow peas and continue cooking.
6. After cooking, stand covered for 2 minutes.
7. Serve with rice or hokkien noodles.

Serves 6

Nutrition per serve

4.4g Fat; 1.8g Saturated fat; 19.3g Protein; 21.4g Carbohydrate; 4.4g Dietary fibre; 891kJ

REHEAT MENU GUIDE

No.	Menu	 Weight Range	 Initial Temperature (approx.)	Procedure	 Standing Time (minutes)
6	Pie includes: Pies Pasties	1 – 6 pieces (1 piece, approx. 160-200 g)	- 18°C Frozen	<ul style="list-style-type: none"> • Place pies upside down on the turntable. • Cover with paper towel. • When oven stops and TURN, OVER is displayed, turn pies over and continue cooking. • After cooking, stand. 	1-3

HINT

To Reheat Beverage

Tea, Coffee, Water(+20°C Room Temperature)



Qty(250 ml per 1 cup)	Cooking Time	Power Level
1 cup	1 min. 20 sec.	HIGH
2 cups	2 min. 30 sec.	HIGH

*Stir after heating.

REHEAT MENU GUIDE

REHEAT

When you cook the following menus with SENSOR COOK, press the REHEAT pad until the desired menu appears in the display.

No.	Menu	 Weight Range	 Initial Temperature (approx.)	Procedure	 Standing Time (minutes)									
1	Dinner Plate	1 serve (approx. 400 g)	+ 3°C Refrigerated	<ul style="list-style-type: none"> Cover with plastic wrap. After cooking, stand covered. 	2									
		<table border="1"> <thead> <tr> <th>MEAT</th> <th>POTATO</th> <th>VEGETABLES</th> </tr> </thead> <tbody> <tr> <td>175-180g</td> <td>125g</td> <td>100g</td> </tr> <tr> <td>Beef, Lamb Chicken, T-Bone</td> <td>sliced</td> <td>2 varieties eg. sliced Carrot, Zucchini Broccoli</td> </tr> </tbody> </table>	MEAT	POTATO	VEGETABLES	175-180g	125g	100g	Beef, Lamb Chicken, T-Bone	sliced	2 varieties eg. sliced Carrot, Zucchini Broccoli			
MEAT	POTATO	VEGETABLES												
175-180g	125g	100g												
Beef, Lamb Chicken, T-Bone	sliced	2 varieties eg. sliced Carrot, Zucchini Broccoli												
2	Casserole Beef Stroganoff Springtime Lamb Chicken Casserole	1 – 4 cups (1 cup, 250 ml)	+ 3°C Refrigerated	<ul style="list-style-type: none"> Place into a casserole dish, and cover with lid. After cooking, stir and stand covered. 	1-5									
	Canned Food Baked Beans Spaghetti		+ 20°C Room temperature											
3	Soup Pumpkin Soup, Potato & Leek Soup Canned Soup	1 – 4 cups (1 cup, 250 ml)	+ 3°C Refrigerated	<ul style="list-style-type: none"> Place in a microwave safe glass bowl. Cover with glass lid or plastic wrap. After cooking, stir. 										
			+ 20°C Room temperature	HINT For other beverages, see HINT on page 15.										
4	Pizza	1 – 6 pieces (1 piece, approx. 90 g)	+ 3°C Refrigerated	<ul style="list-style-type: none"> Place pizza on paper towel on the turntable. 										
5	Rice includes : White rice Brown rice Fried rice	1 – 4 cups (1 cup, 250 ml)	+ 3°C Refrigerated	<ul style="list-style-type: none"> Place into a casserole dish, and cover with lid. After cooking, stir. 										



DESSERTS MENU GUIDE

DESSERTS

When you cook the following menus with SENSOR COOK, press the DESSERTS pad until the desired menu appears in the display.

No.	Menu	Weight Range	Initial Temperature (approx.)	Procedure	Standing Time (minutes)
1	Cake Packet cake	1 packet	+20°C Room temperature	<ul style="list-style-type: none"> Follow ingredient instructions on packet. Pour into microwave ring container. –Approx. 21 cm. After cooking stand before turning out. 	3
2	Stewed Fruit Fruit (apples, pears etc.)	0.1-1.0 kg	+3°C Refrigerated	<ul style="list-style-type: none"> Wash, peel and core fruit. Remove stone if necessary and slice thinly. Place in a microwave safe glass bowl. Cover with a glass lid or plastic wrap. After cooking, stand covered and stir. 	1–5
3	Pudding	2 – 8 serves		<ul style="list-style-type: none"> Combine flour, cocoa, caster sugar in a pudding bowl. Stir in milk, chocolate and butter. Mix until smooth. In a separate bowl, mix brown sugar, extra cocoa powder and boiling water. Pour over mixture. After cooking, stand. 	3–5
	Serve	2-4 serves	4-6 serves		
	Ingredients;	Self-Raising Flour cocoa powder caster sugar milk dark cooking chocolate, melted butter, melted brown sugar cocoa, extra boiling water	1/2 cup 1 tbs 1/4 cup 1/4 cup 50 g 30 g 1/2 cup 1 tbs 1 cup	3/4 cup 2 tbs 1/3 cup 1/2 cup 100 g 60 g 3/4 cup 2 tbs 1 1/2 cups	1 1/4 cups 3 tbs 1/2 cup 3/4 cup 150 g 90 g 1 1/4 cups 3 tbs 2 1/2 cups
4	Crunch	2 – 8 serves		<ul style="list-style-type: none"> Place pie apple in a shallow dish. Sprinkle evenly with dry cake mix. Layer sliced butter over cake mix. Combine brown sugar, coconut, nuts and cinnamon. Sprinkle over butter. After cooking, stand. 	3–5
	Serve	2-4 serves	4-6 serves		
	Ingredients;	can pie apples White Wings butter cake mix butter, cut into thin slices brown sugar coconut crushed nuts cinnamon	400 g 1/2 cup 50 g 1 tbs 1 tbs 1 tbs 1/2 ts	600 g 3/4 cup 75 g 2 tbs 2 tbs 2 tbs 1 ts	800 g 1 1/2 cups 140 g 3 tbs 3 tbs 3 tbs 1 ts
5	Muesli Delight	2 – 8 serves		<ul style="list-style-type: none"> In a medium bowl rub the butter into the flour and sugar. Add all other ingredients and mix well to combine. Spoon into a rectangle shaped microwave safe dish and press down firmly. After cooking, stand before turning out on a wire rack to cool. 	3–5
	Serve	2-4 serves	4-6 serves		
	Ingredients;	brown sugar flour butter coconut muesli peaches milk	1/2 cup 1/2 cup 30 g 1 tbs 3/4 cup 140 g 2 ts	1 cup 1 cup 60 g 2 tbs 1 1/2 cups 250 g 1 tbs	1 1/2 cups 1 1/2 cups 90 g 1/4 cup 2 1/2 cups 250 g 3 tbs

RICE / PASTA MENU GUIDE

No.	Menu	 Weight Range	 Initial Temperature (approx.)	Procedure	 Standing Time (minutes)														
6	Porridge	1 - 4 serves	+20°C Room temperature	<ul style="list-style-type: none"> Place into a deep microwave safe glass bowl and add water. Cook uncovered. Stir after cooking. 															
	<table border="1"> <thead> <tr> <th></th> <th>Porridge</th> <th>Water</th> </tr> </thead> <tbody> <tr> <td>1serve</td> <td>1/3 cup</td> <td>3/4 cup</td> </tr> <tr> <td>2serves</td> <td>2/3 cup</td> <td>1 1/2 cups</td> </tr> <tr> <td>3serves</td> <td>1 cup</td> <td>2 1/4 cups</td> </tr> <tr> <td>4serves</td> <td>1 1/3 cups</td> <td>3 cups</td> </tr> </tbody> </table>		Porridge	Water	1serve	1/3 cup	3/4 cup	2serves	2/3 cup	1 1/2 cups	3serves	1 cup	2 1/4 cups	4serves	1 1/3 cups	3 cups			
	Porridge	Water																	
1serve	1/3 cup	3/4 cup																	
2serves	2/3 cup	1 1/2 cups																	
3serves	1 cup	2 1/4 cups																	
4serves	1 1/3 cups	3 cups																	



RICE / PASTA MENU GUIDE

RICE/
PASTA

When you cook the following menus with SENSOR COOK, press the RICE/PASTA pad until the desired menu appears in the display.

No.	Menu	Weight Range	Initial Temperature (approx.)	Procedure	Standing Time (minutes)									
1	White Rice	1/2 - 4 cups	+60°C hot tap water or soup stock	<ul style="list-style-type: none"> Wash rice until water runs clear. Place into a microwave safe glass bowl and cover with hot tap water or soup stock. Cook uncovered. When oven stops and STIR is displayed, stir and continue cooking. After cooking stand and stir. 	3-5									
						<table border="1"> <tr> <td>Rice</td> <td>1/2 cup</td> <td>1 cup</td> <td>1 1/2 cups</td> <td>2 cups</td> <td>3 cups</td> <td>4 cups</td> </tr> <tr> <td>Hot tap water or soup stock (1 cup=250ml)</td> <td>2 cups</td> <td>2 1/2 cups</td> <td>3 cups</td> <td>4 cups</td> <td>4 1/2 cups</td> <td>6 cups</td> </tr> </table>	Rice	1/2 cup	1 cup	1 1/2 cups	2 cups	3 cups	4 cups	Hot tap water or soup stock (1 cup=250ml)
Rice	1/2 cup	1 cup	1 1/2 cups	2 cups	3 cups	4 cups								
Hot tap water or soup stock (1 cup=250ml)	2 cups	2 1/2 cups	3 cups	4 cups	4 1/2 cups	6 cups								
2	Dry Pasta	1/2 - 4 cups	+60°C hot tap water	<ul style="list-style-type: none"> Place into a microwave safe glass bowl and cover with hot tap water. Cook uncovered. When oven stops and STIR is displayed, stir and continue cooking. After cooking, stand and stir. 	3-5									
						<table border="1"> <tr> <td>Pasta</td> <td>1/2 cup</td> <td>1 cup</td> <td>1 1/2 cups</td> <td>2 cups</td> <td>3 cups</td> <td>4 cups</td> </tr> <tr> <td>Hot tap water (1 cup=250ml)</td> <td>2 cups</td> <td>2 1/2 cups</td> <td>3 cups</td> <td>4 cups</td> <td>5 cups</td> <td>6 cups</td> </tr> </table>	Pasta	1/2 cup	1 cup	1 1/2 cups	2 cups	3 cups	4 cups	Hot tap water (1 cup=250ml)
Pasta	1/2 cup	1 cup	1 1/2 cups	2 cups	3 cups	4 cups								
Hot tap water (1 cup=250ml)	2 cups	2 1/2 cups	3 cups	4 cups	5 cups	6 cups								
3	Fresh Pasta Tortellini Ravioli Fettuccine	1/2 - 4 cups	+60°C hot tap water	<ul style="list-style-type: none"> Place into a microwave safe glass bowl and cover with hot tap water. Cook uncovered. When oven stops and STIR is displayed, stir and continue cooking. After cooking, stand and stir. 	3-5									
						<table border="1"> <tr> <td>Pasta</td> <td>1/2 cup</td> <td>1 cup</td> <td>1 1/2 cups</td> <td>2 cups</td> <td>3 cups</td> <td>4 cups</td> </tr> <tr> <td>Hot tap water (1 cup=250ml)</td> <td>2 cups</td> <td>2 1/2 cups</td> <td>3 cups</td> <td>4 cups</td> <td>5 cups</td> <td>6 cups</td> </tr> </table>	Pasta	1/2 cup	1 cup	1 1/2 cups	2 cups	3 cups	4 cups	Hot tap water (1 cup=250ml)
Pasta	1/2 cup	1 cup	1 1/2 cups	2 cups	3 cups	4 cups								
Hot tap water (1 cup=250ml)	2 cups	2 1/2 cups	3 cups	4 cups	5 cups	6 cups								
4	Instant Noodles	1 - 2 pkts (1 pkt = approx. 85g)	+60°C hot tap water	<ul style="list-style-type: none"> Place into a microwave safe glass bowl and cover with hot tap water. Cook uncovered. When oven stops and STIR is displayed, stir and continue cooking. After cooking, stand and stir. <p>N.B. For small quantities, the food may not require a stir during cooking.</p>	1									
						<table border="1"> <tr> <td>Noodles</td> <td>1 pkt</td> <td>2 pkts</td> </tr> <tr> <td>Hot tap water (1 cup=250ml)</td> <td>2 cups</td> <td>4 cups</td> </tr> </table>	Noodles	1 pkt	2 pkts	Hot tap water (1 cup=250ml)	2 cups	4 cups		
Noodles	1 pkt	2 pkts												
Hot tap water (1 cup=250ml)	2 cups	4 cups												
5	Frozen Pasta Tortellini Ravioli	1/2 - 4 cups	+60°C hot tap water	<ul style="list-style-type: none"> Place into a microwave safe glass bowl and cover with hot tap water. Cook uncovered. When oven stops and STIR is displayed, stir and continue cooking. After cooking, stand and stir. 	3-5									
						<table border="1"> <tr> <td>Pasta</td> <td>1/2 cup</td> <td>1 cup</td> <td>1 1/2 cups</td> <td>2 cups</td> <td>3 cups</td> <td>4 cups</td> </tr> <tr> <td>Hot tap water (1 cup=250ml)</td> <td>2 cups</td> <td>2 1/2 cups</td> <td>3 cups</td> <td>4 cups</td> <td>5 cups</td> <td>6 cups</td> </tr> </table>	Pasta	1/2 cup	1 cup	1 1/2 cups	2 cups	3 cups	4 cups	Hot tap water (1 cup=250ml)
Pasta	1/2 cup	1 cup	1 1/2 cups	2 cups	3 cups	4 cups								
Hot tap water (1 cup=250ml)	2 cups	2 1/2 cups	3 cups	4 cups	5 cups	6 cups								

VEGETABLES MENU GUIDE

No.	Menu	 Weight Range	 Initial Temperature (approx.)	Procedure	 Standing Time (minutes)		
5	Fresh Soup	2-12 serves	+ 20°C Room temperature	<ul style="list-style-type: none"> Combine all ingredients except cream and nutmeg in a casserole dish and cover with plastic wrap or glass lid. When oven stops and STIR is displayed, stir soup. Continue cooking covered. The oven will stop again and display STIR. Stir soup and continue cooking covered. After cooking, stir and place in a blender or processor and blend until smooth. Transfer to a serving bowl and stir in cream and nutmeg. Season to taste. 			
	<i>Pumpkin Soup</i>						
	Serves	2-4 serves	4-6 serves			6-8 serves	8-12 serves
	Ingredients;	500 g	1000 g			1500 g	2000 g
	pumpkin small onion chicken stock cream nutmeg, salt, pepper	1 1/2 cup 1/2 cup to taste	2 1 cup 1 cup to taste			3 1 1/2 cups 1 1/2 cups to taste	4 2 cups 2 cups to taste
	<i>Potato and Leek Soup</i>			<ul style="list-style-type: none"> Combine butter, leeks, potatoes and stock in a casserole dish. Cover with plastic wrap or a lid. When oven stops and STIR is displayed, stir soup. Continue cooking covered. The oven will stop again and display STIR. Stir soup and continue cooking covered. After cooking, stir and place in a blender or processor and blend until smooth. Transfer to a serving bowl and stir in worcestershire sauce and cream. Season to taste. 			
Serves	2-4 serves	4-6 serves	6-8 serves			8-12 serves	
Ingredients;	50 g	75 g	100 g			125 g	
butter leeks (sliced and washed) potatoes, peeled and cubed chicken stock worcestershire sauce cream salt and pepper	1 2 1 cup 1/2 ts 1/2 cup to taste	2 3 2 cups 1 ts 1 cup to taste	3 4 3 cups 1 1/2 ts 1 1/2 cups to taste			4 5 4 cups 2 ts 2 cups to taste	

SENSOR MENUS MENU GUIDE

The final cooking result will vary according to the food condition (e.g. initial temperature, shape, quality). Check the food after cooking and if necessary continue cooking manually.



VEGETABLES MENU GUIDE

VEGETABLES

When you cook the following menus with SENSOR COOK, press the VEGETABLES pad until the desired menu appears in the display.

No.	Menu	Weight Range	Initial Temperature (approx.)	Procedure	Standing Time (minutes)
1	Fresh Vegetables Hard Carrots Potato Beans Broccoli Cauliflower Pumpkin	0.1-1.0 kg	+ 3°C Refrigerated	<ul style="list-style-type: none"> Wash the vegetables. Arrange the vegetables in a shallow dish. Cover with a glass lid or plastic wrap. After cooking, stir then stand covered. 	1-5
2	Fresh Vegetables Soft Brussels Sprouts Zucchini Spinach Cabbage Squash	0.1-1.0 kg	+ 3°C Refrigerated	<ul style="list-style-type: none"> Wash the vegetables. Pierce skin of squash with fork. Arrange the vegetables in a shallow dish. Cover with a glass lid or plastic wrap. After cooking, stir then stand covered. 	1-5
3	Frozen Vegetables Carrots Beans Brussels Sprouts Broccoli Cauliflower Corn Green Peas Mixed Vegetables	0.1-1.0 kg	-18°C Frozen	<ul style="list-style-type: none"> Before cooking, separate vegetables eg. broccoli as much as possible. Arrange the vegetables in a shallow dish in the following way : hard vegetables around the outside, soft vegetables in the centre, medium vegetables in-between. Cover with a glass lid or plastic wrap. After cooking, stir then stand covered. 	1-5
4	Jacket Potato Potato (whole)	1-10 pieces 1 piece, (approx. 180-200 g)	+ 20°C Room temperature	<ul style="list-style-type: none"> Use washed new potatoes. Pierce twice with fork on each side. Place on outside of turntable. When oven stops and TURN, OVER is displayed, turn potatoes over and continue cooking. After cooking, stand covered with aluminium foil. <p>N.B. For small quantities, the food may not require a turn over during cooking.</p>	3-10





EXPRESS COOK MENU GUIDE

No.	Menu	 Weight Range	 Initial Temperature (approx.)	Procedure	 Standing Time (minutes)
5	Chilled Roast Chicken	1.0-2.5 kg	+3°C Refrigerated	<ul style="list-style-type: none"> Season with season salt or as desired. Place breast side down on a roasting rack in a casserole dish. Cover loosely with paper towel. When oven stops and TURN, OVER is displayed, turn chicken over and season. Cover loosely with paper towel, and continue cooking. After cooking, stand covered with aluminium foil. 	5-15
6	Frozen Roast Chicken	1.0-2.5 kg	-18°C Frozen	<ul style="list-style-type: none"> Place breast side up on a roasting rack in a casserole dish. When oven stops and TURN OVER COVER WITH PAPER TOWEL is displayed, turn chicken over and cover loosely with paper towel, and season with season salt or as desired. When oven stops again and TURN, OVER is displayed, turn chicken over and season. Cover loosely with paper towel, and continue cooking. After cooking, stand covered with aluminium foil. 	5-15

EXPRESS DEFROST MENU GUIDE

EXPRESS
DEFROST

When you cook the following menus with EXPRESS MENUS, press the EXPRESS DEFROST pad until the desired menu appears in the display.



No.	Menu	 Quantity	Procedure	 Standing Time (minutes)
1	Fish Fillets 	0.5 kg	<ul style="list-style-type: none"> Place fish fillets on a defrost rack. When the oven has stopped, turn over and separate into pieces. Shield edges with foil strips. After defrost time, stand covered with aluminium foil. 	5
2	Chicken Fillets 	0.5 kg	<ul style="list-style-type: none"> Place chicken fillets on a defrost rack. When the oven has stopped, turn over and separate into pieces. Shield edges with foil strips. After defrost time, stand covered with aluminium foil. 	5
3	Sausages / Minced Meat 	0.5 kg	<ul style="list-style-type: none"> Place sausages / minced meat on a defrost rack. When the oven has stopped, remove defrosted portions of mince, turn over and separate into pieces. Shield edges with foil strips. After defrost time, stand covered with aluminium foil. 	5

NOTE: When freezing minced meat, shape it into flat even sizes.
For fish fillets, chicken fillets and sausages freeze separately in single flat layers and if necessary separate into layers with freezer plastic.
This will ensure even defrosting.
It is also a good idea to label the packs with the correct weights.

EXPRESS COOK MENU GUIDE

EXPRESS
COOK

When you cook the following menus with EXPRESS MENUS, press the EXPRESS COOK pad until the desired menu appears in the display.

No.	Menu	 Weight Range	 Initial Temperature (approx.)	Procedure	 Standing Time (minutes)
1	Chilled Roast Beef * You can select desired cooking result. MORE - Well done STD - Medium	0.5-3.0 kg	+3°C Refrigerated	<ul style="list-style-type: none"> • Use netted roast beef. • Shield edges. • Place fat side down on a roasting rack in a casserole dish. • When oven stops and TURN, OVER is displayed, turn beef over and continue cooking. • After cooking, stand covered with aluminium foil. 	5-15
2	Frozen Roast Beef * You can select desired cooking result. MORE - Well done STD - Medium	0.5-3.0 kg	-18°C Frozen	<ul style="list-style-type: none"> • Use netted roast beef. • Shield edges. • Place fat side up on a roasting rack in a casserole dish. • When oven stops and TURN, OVER is displayed, turn beef over and shield warm areas. Then continue cooking. • When oven stops again and TURN, OVER is displayed, turn beef over and continue cooking. • After cooking, stand covered with aluminium foil. 	5-15
3	Chilled Roast Lamb * You can select desired cooking result. MORE - Well done STD - Medium	0.5-2.5 kg	+3°C Refrigerated	<ul style="list-style-type: none"> • Place fat side down on a roasting rack in a casserole dish and season. • Cover loosely with paper towel. • When oven stops and TURN, OVER is displayed, turn lamb over. • Cover loosely with paper towel, and continue cooking. • After cooking, stand covered with aluminium foil. 	5-15
4	Frozen Roast Lamb * You can select desired cooking result. MORE - Well done STD - Medium	0.5-2.5 kg	-18°C Frozen	<ul style="list-style-type: none"> • Place fat side up on a roasting rack in a casserole dish. • When oven stops and TURN OVER COVER WITH PAPER TOWEL is displayed, turn lamb over and cover loosely with paper towel, and season. • When oven stops again and TURN, OVER is displayed, turn lamb over. • Cover loosely with paper towel, and continue cooking. • After cooking, stand covered with aluminium foil. 	5-15

NOTE : When purchasing Roast Beef, ensure that it is netted by the butcher.

EXPRESS MEAL RECIPES

CASSEROLE

Beef Casserole

- 500 g rump or blade steak, cut into strips
- 2 tablespoons flour
- 1/2 cup green onions, finely sliced
- 2 cups mushroom, finely sliced
- 1/4 cup red wine
- 1 1/2 cups beef stock
- 1 tablespoon cream
- 2 tablespoons tomato paste
- 1 bay leaf
- 1 sprig of rosemary
- salt and pepper to taste

1. In a freezer bag add flour and beef, and toss until the beef is evenly coated.
2. Add all ingredients including the beef to a 3 litre casserole dish and mix well.
3. Cover with a lid and place on turntable.
4. Cook on EXPRESS MEAL "CASSEROLE".
5. When oven stops with STIR displayed, stir and continue cooking.
6. After cooking, stir and stand covered for 3 mins.

Chicken Casserole

- 500 g chicken breast, cut into strips
- 2 tablespoons flour
- 1/2 cup green onions, finely sliced
- 1 clove garlic, crushed
- 1 stick celery, finely sliced
- 2 cups mushroom, sliced
- 1/2 cup dry white wine
- 1 400g can chopped tomatoes
- 1 teaspoon dried oregano
- 1 sprig rosemary
- salt and pepper to taste

1. In a freezer bag add flour and chicken, and toss until the chicken is evenly coated.
2. Add all ingredients including the chicken to a 3 litre casserole dish and mix well.
3. Cover with a lid and place on turntable.
4. Cook on EXPRESS MEAL "CASSEROLE".
5. When oven stops with STIR displayed, stir and continue cooking.
6. After cooking, stir and stand covered for 3 mins.

Springtime Lamb Casserole

- 500 g lamb, cubed
- 1 packet French onion soup mix
- 1 tablespoon flour
- 3 green onions, quartered
- 2 carrots, finely sliced
- 2 sticks celery, finely sliced
- 1 can 310 g corn
- 1 1/2 cups chicken stock
- 2 teaspoons fresh parsley or 1 teaspoon dried parsley
- 1 sprig of fresh rosemary or 1 teaspoon dried rosemary
- salt and pepper to taste

1. In a freezer bag add flour, French onion soup and lamb, and toss until the lamb is evenly coated.
2. Add all ingredients including the lamb to a 3 litre casserole dish and mix well.
3. Cover with a lid and place on turntable.
4. Cook on EXPRESS MEAL "CASSEROLE".
5. When oven stops with STIR displayed, stir and continue cooking.
6. After cooking, stir and stand covered for 3 mins.

EXPRESS MEAL RECIPES

RISOTTO

Beef and Mushroom

- 250 g beef fillet, cubed or use veal
- 1 cup mushrooms, finely sliced
- 1/2 cup green onions, finely sliced
- 1 cup arborio rice
- 1 tablespoon tomato paste
- 1/2 cup dry white wine
- 2 1/2 cups of chicken stock
- 1 bay leaf
- salt and pepper to taste

1. Place all ingredients in a 3 litre casserole dish and mix well.
2. Place on turntable uncovered.
3. Cook on EXPRESS MEAL "RISOTTO".
4. When oven stops with STIR displayed, stir and continue cooking.
5. After cooking, stir and stand for 3 mins. Serve with parmesan cheese.

Seafood Risotto

- 300 g seafood marinara mix (chilled)
- 1 clove garlic, crushed
- 1/2 cup green onions, finely sliced
- 1 cup arborio rice
- 1/2 cup dry white wine
- 2 plum tomatoes, chopped
- 2 tablespoons tomato paste
- 2 1/2 cups of stock (fish or chicken)
- salt and pepper to taste

1. Place all ingredients in a 3 litre casserole dish and mix well.
2. Place on turntable uncovered.
3. Cook on EXPRESS MEAL "RISOTTO".
4. When oven stops with STIR displayed, stir and continue cooking.
5. After cooking, stir and stand for 3 mins.

Chicken Risotto

- 250 g cooked chicken, chopped
- 1/2 cup green onions, finely sliced
- 2 cups assorted finely chopped vegetables (eg. carrot, zucchini, mushroom, corn)
- 1 cup arborio rice
- 1/2 cup dry white wine
- 2 1/2 cups chicken stock
- salt and pepper to taste

1. Place all ingredients in a 3 litre casserole dish and mix well.
2. Place on turntable uncovered.
3. Cook on EXPRESS MEAL "RISOTTO".
4. When oven stops with STIR displayed, stir and continue cooking.
5. After cooking, stir and stand for 3 mins.

EXPRESS MENUS MENU GUIDE

The final cooking result will vary according to the food condition (e.g. initial temperature, shape, quality). Check the food after cooking and if necessary continue cooking manually.

EXPRESS MEAL RECIPES

PASTA DISH

Pasta Bolognaise

- 250 g lean mince meat
- 1/2 cup green onions, finely sliced
- 1 cup mushroom, finely sliced
- 1 clove garlic, crushed
- 1 400g can chopped tomatoes
- 1/2 cup tomato paste
- 500 ml beef stock
- 1/2 cup dry red wine
- 1 bay leaf
- 1 tablespoon dried mixed herbs
- 300 g dried pasta
- salt and pepper to taste
- 1/2 teaspoon sugar

1. Place all ingredients in a 3 litre casserole dish and mix well.
2. Cover with a lid and place on turntable.
3. Cook on EXPRESS MEAL "PASTA DISH"
4. When oven stops with STIR displayed, stir and continue cooking.
5. After cooking, stir and stand covered for 3 mins.

Pasta Napolitana

- 1 400g can chopped tomatoes
- 2 tablespoons tomato paste
- 1 clove garlic, crushed
- 1/2 cup green onions, finely sliced
- 1 teaspoon sugar
- 500 ml hot water
- 1 teaspoon gourmet vegetable stock (Vegeta)
- 300 g dried pasta
- salt and pepper to taste









1. Place all ingredients in a 3 litre casserole dish and mix well.
2. Cover with a lid and place on turntable.
3. Cook on EXPRESS MEAL "PASTA DISH"
4. When oven stops with STIR displayed, stir and continue cooking.
5. After cooking, stir and stand covered for 3 mins.

Spaghetti Marinara

- 1 400g can chopped tomatoes
- 2 tablespoons tomato paste
- 1 clove garlic, crushed
- 1/2 cup green onions, finely sliced
- 250 g seafood marinara mix (chilled)
- 1 teaspoon sugar
- 500 ml chicken stock
- 1/2 cup dry white wine
- 300 g dried spaghetti, snapped in half

1. Place all ingredients in a 3 litre casserole dish and mix well.
2. Cover with a lid and place on turntable.
3. Cook on EXPRESS MEAL "PASTA DISH"
4. When oven stops with STIR displayed, stir and continue cooking.
5. After cooking, stir and stand covered for 3 mins.

COOKWARE AND UTENSIL GUIDE

Utensil	Use	Advice
GLASSWARE/CERAMIC (HEAT RESISTANT) 	YES	GLASSWARE <ul style="list-style-type: none"> • Ordinary glass is not suitable for cooking but may be used for short periods for heating foods. CERAMIC <ul style="list-style-type: none"> • Most ovenproof china, and ceramics, are suited. • Avoid dishes that are decorated with gold or silver leaf. • Avoid using antique pottery. • If unsure, check with the manufacturer.
METAL COOKWARE 	NO	<ul style="list-style-type: none"> • Metal cookware should be avoided when cooking in the microwave oven. • Microwave energy is reflected by metal.
PLASTIC WRAP/ OVEN BAGS (MICROWAVE SAFE ONLY) 	YES	<ul style="list-style-type: none"> • Plastic wrap can be used to cover food. • Some shrinkage of the wrap may occur, over an extended cooking time. • When removing wrap, lift it in such a way to avoid steam burns. • Do not tie oven bags with metal twist ties, substitute with string. • For cooking food with high fat content, do not bring the wrap in contact with the food as it may melt.
ALUMINIUM FOIL 	FOR SHIELDING	<ul style="list-style-type: none"> • Small amounts may be used to shield certain parts of meat and fish when cooking or defrosting. • Remove food in foil trays, if possible, and place in a microwave safe dish. • If not possible, place the foil tray onto a heat proof plate allowing 2.5 cm room between the walls of the oven.
STRAW AND WOOD 	NO	<ul style="list-style-type: none"> • Excessive over heating of these materials may cause a fire in the microwave oven.
PAPER 	YES	<ul style="list-style-type: none"> • Paper towels and waxed paper are suitable to use to prevent splatters. • These are suitable for use when reheating foods or for short cooking times.
PLASTIC COOKWARE MICROWAVE SAFE 	YES	<ul style="list-style-type: none"> • Ideal for cooking, reheating and defrosting. • Some microwave safe plastic cookware are not suitable for cooking foods with high fat and sugar content.
BROWNING DISH 	YES	<ul style="list-style-type: none"> • Ensure that the preheating time of the dish is not exceeded. • Ensure that a microwave heat proof dinner plate or suitable insulator be placed between the turntable and the browning dish.
THERMOMETERS <ul style="list-style-type: none"> • MICROWAVE SAFE • CONVENTIONAL 	YES NO	

HELPFUL HINTS

1. THE ARRANGEMENT

Arrange foods carefully. Place thickest areas toward outside of dish.



3. COVERING

Cover foods in the microwave if you would normally cover the food in your ordinary oven, or to retain moisture. Cover foods such as Vegetables, Casseroles, or when Reheating.

Use to cover foods:



LID



PLASTIC WRAP

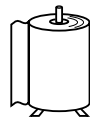

PAPER TOWEL

5. SHIELDING

Shield using small pieces of aluminium foil to shield thin areas of meat, fish and poultry or edges of cakes to prevent overcooking.



FISH



CHICKEN

7. STIRRING

Stir foods from the outside to the center of the dish, once or twice during cooking if possible.

Eg. Casseroles and Sauces.



9. DENSITY

The depth to which microwaves penetrate food varies depending on the food's density. Porous foods like minced beef or mashed potatoes microwave faster than dense ones like steak or whole potatoes.

11. STARTING TEMPERATURE

Frozen or refrigerated foods take longer to heat than food at room temperature. Cooking times in this book are based on normal storage temperatures. Since rooms, refrigerators and freezers differ in temperature, check cooking result at the minimum time.



13. CONDENSATION

Condensation is a normal part of microwave cooking. The humidity and moisture in food will influence the amount of condensation in the oven. Generally, covered foods will not cause as much condensation as uncovered foods. Ensure that the ventilation openings are not blocked.

2. TURNING

Foods such as poultry and joints of meat should be turned over after half the cooking time.

4. PIERCING

Pierce potatoes, eggs, tomatoes or any foods with a skin or membrane to allow steam to escape.



TOMATO



EGG

6. STANDING TIME

Standing time is important. After cooking or defrosting ensure adequate standing time. This allows the food to continue cooking or heating. Refer to cooking guides for each menu or according to manufacturers instructions.

8. SIZE

Small pieces cook faster than large ones. To speed up cooking, cut pieces smaller than 5 cm so microwaves can penetrate to the center from all sides. For even cooking, make all the pieces the same size.

10. FAT AND BONE

Marbling within meat, or a thin, even layer of fat on a roast, speeds cooking. Large fatty areas or excess drippings in dish attract energy away from meat, and slows cooking. Center bones do not affect cooking, but bone on the side of meat conducts heat to the areas next to it.

























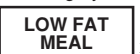

















12. QUANTITY

Microwave cooking times are directly related to the amount of food in the oven. Because energy is absorbed by the food itself, one potato or a single piece of chicken cooks rapidly. When the energy is divided among several items, cooking takes more time.

14. GENERAL

Your microwave oven is capable of heating food and beverages very quickly therefore, it is very important that you select the appropriate cooking time and power level for the type and quantity of food to be heated. If you are unsure of the cooking time and power level required, begin with low cooking times and power levels until the food is sufficiently heated evenly throughout.

QUICK REFERENCE GUIDE

FEATURE	QUICK OPERATION GUIDE
Sensor Menus (Vegetables, Rice/Pasta, Desserts and Reheat)	Menu Category and Menu  →  eg. Cake
Quick and Easy	Menu  →  eg. Chicken Caesar Salad
Express Menus (Express Defrost, Express Meal)	Menu Category and Menu  →  eg. Chicken Fillets
Express Menus (Express Cook)	Menu Category and Menu Weight  →   →  eg. Roast Beef Chilled eg. 1.0kg
Easy Defrost	Menu Weight  →   →  eg. Poultry eg. 1.0kg
Healthy Menus (Low Fat Meal, Vegetarian Meal)	Menu Category and Menu  →  eg. Lemon Fish Fillets
More or Less	Menu Weight*  →  →   →  eg. Poultry eg. 1.0kg * Sensor Menus, Quick and Easy, Healthy Menus and Express Defrost / Express Meal of Express Menus do not need to enter weight.
Variable Cooking Control	To soften Cream Cheese or Butter for 40 seconds on 30%. Cooking Time   →  → 
Timer	To set for 3 minutes.  →    → 
Child Lock	To lock.  →  →  Press for 3 seconds
	To unlock.  →  → 
Instant Cook	Just One Touch  During cooking in manual operations Not during cooking operation: Within 3 minutes of closing the door, cooking completion or pressing the STOP/CLEAR pad.
Clock	To set for 11:45 am  →     → 



SHARP

RECIPES

INDEX

MEAT

CHILLI CON CARNE	24
GOLDEN CURRY SAUSAGES	23
HONEY ROAST LAMB	24
INDIAN CURRY LAMB	24
ITALIAN SPAGHETTI SAUCE	24
LASAGNE	23
SHEPHERD'S PIE	23
VEAL AND EGGPLANT	24

POULTRY

CHICKEN PENNE SALAD	25
CHICKEN FILLET BURGERS	25
CHICKEN IN A POT	25
CHICKEN WITH BACON AND LEEK SEASONING	25
CRUNCHY CAMEMBERT CHICKEN	26
HONEY CHICKEN LEGS	26
SEASONED CHICKEN PARCELS	26
TANDOORI CHICKEN	26

SEAFOOD

CHEESY SALMON CANNELLONI	27
CRAB MORNAY	27
GARLIC MUSSELS	27
SEAFOOD LAKSA	27
SMOKED SALMON TAGLIATELLE	27

VEGETABLES

CAULIFLOWER AU GRATIN	28
EASY HOME-MADE RISOTTO	28
HONEY CARROTS	28
HONEY GINGERED VEGETABLES	29
POTATOES PIZZAIOLA	29
POTATO, AVOCADO AND ONION SALAD	29
PUMPKIN SALAD	29
SCALLOPED POTATOES	29
STUFFED BAKED POTATOES	29
VEGETABLE PLATTER	29

DESSERTS

AUSTRALIAN FRUIT CAKE	30
BREAD AND BUTTER PUDDING	30
CARAMEL RICE PUDDING	30
CHOCOLATE MOUSSE	30
CHOCOLATE CAKE	30

CHARTS

DEFROSTING	31
FRESH VEGETABLE CHART	33
FROZEN VEGETABLE CHART	34
GENERAL INFORMATION	36-38
GLOSSARY OF TERMS	36
GUIDE TO COOKING EGGS	34
MICROWAVE OVEN ROASTING CHART	32
REHEATING CONVENIENCE	
DEFROSTING CONVENIENCE-FOOD CHART	35
RICE AND PASTA COOKING CHART	34

CONTENTS COOKING GUIDE

QUICK REFERENCE GUIDE	HELPFUL HINTS	COOKWARE AND UTENSIL GUIDE	EXPRESS MENUS MENU GUIDE	SENSOR MENUS MENU GUIDE	HEALTHY MENUS MENU GUIDE	EASY DEFROST MENU GUIDE	QUICK AND EASY RECIPES	RECIPES
①	②	③	④ - ⑧	⑨ - ⑮	⑯ - ⑲	⑳	㉑ - ㉒	㉓ - ㉘

SHARP

SHARP CORPORATION OSAKA, JAPAN